



875-0425-10

User Guide
Revision: A5
October 29, 2020

**Vector™ VS1000
GNSS Receiver**

Table of Contents

Device Compliance, License and Patents.....	4
VS1000 Terms and Definitions.....	6
Chapter 1: Introduction	9
Overview	9
Product Overview	10
Key Features.....	12
Parts List.....	13
Firmware Upgrades.....	14
Using PocketMax to Communicate with the VS1000	18
Chapter 2: Installing the VS1000.....	19
Overview	19
System Orientation	20
Mounting the Antennas.....	21
A45 Antenna	22
Routing and Securing the Antenna Cable	25
Mounting the VS1000	27
Dimensions.....	33
Connectors	34
Connecting the Receiver to External Devices	35
Power Considerations	36
Chapter 3: Operating the VS1000.....	39
Overview	39
Powering the Receiver On/Off.....	40
Configuring the VS1000 Using the WebUI (Bluetooth/Wi-Fi)	42
Configuring the VS1000 Using the WebUI (Ethernet)	64
Common Commands and Messages.....	83
Appendix A: Technical Specifications	93
Overview	93

VS1000 Technical Specifications	94
Appendix B: Menu Maps.....	100
Overview	100
VS1000 Menu Map	101
Index.....	106
End User License Agreement	108
Warranty Notice.....	112

Device Compliance, License and Patents

Device Compliance This device complies with part 15 of the FCC Rules. Operation is subject to the following two conditions:
This device may not cause harmful interference, and this device must accept any interference received, including interference that may cause undesired operation.

This product complies with the essential requirements and other relevant provisions of Directive 2014/53/EU. The declaration of conformity may be consulted at [HTTPS://HEMISPHEREGNSS.COM/ABOUT-US/QUALITY-COMMITMENT](https://hemispheregnss.com/about-us/quality-commitment).

E-Mark Statement: This product is not to be used for driverless/autonomous driving.

Copyright Notice Copyright Hemisphere GNSS, Inc. (2020). All rights reserved.
No part of this manual may be reproduced, transmitted, transcribed, stored in a retrieval system or translated into any language or computer language, in any form or by any means, electronic, mechanical, magnetic, optical, chemical, manual or otherwise, without the prior written permission of Hemisphere GNSS.

Trademarks Hemisphere GNSS®, the Hemisphere GNSS logo, TRACER™, Crescent®, Eclipse™, e-Dif®, L-Dif™, PocketMax4™, S320™, SBX-4™, Vector™, XF1™, and XF2™ are proprietary trademarks of Hemisphere GNSS, Inc. Other trademarks are the properties of their respective owners.

Patents Hemisphere GNSS products may be covered by one or more of the following patents:

Patents			
6111549	6876920	7400956	8000381
6397147	7142956	7429952	8018376
6469663	7162348	7437230	8085196
6501346	7277792	7460942	8102325
6539303	7292185	7689354	8138970
6549091	7292186	7808428	8140223
6711501	7373231	7835832	8174437
6744404	7388539	7885745	8184050
6865465	7400294	7948769	8190337
8214111	8217833	8265826	8271194
8307535	8311696	8334804	RE41358

Australia Patents	
2002244539	2002325645
2004320401	

Continued on next page

Device Compliance, License and Patents, Continued

Notice to Customers Contact your local dealer for technical assistance. To find the authorized dealer near you:

Hemisphere GNSS, Inc
8515 East Anderson Drive
Scottsdale, AZ 85255 USA
Phone: (480) 348-6380
Fax: (480) 270-5070
PRECISION@HGSS.COM
WWW.HGSS.COM

Technical Support If you need to contact Hemisphere GNSS Technical Support:

Hemisphere GNSS, Inc.
8515 East Anderson Drive
Scottsdale, AZ 85255 USA
Phone: (480) 348-6380
Fax: (480) 270-5070
SUPPORT.HGSS.COM

Documentation Feedback Hemisphere GNSS is committed to the quality and continuous improvement of our products and services. We urge you to provide Hemisphere GNSS with any feedback regarding this guide by opening a support case at the following website: SUPPORT.HGSS.COM

VS1000 Terms and Definitions

Terms & definitions

The following is a list of terms and definitions used in this document.

Term	Definition
1PPS	1 pulse-per-second is a pulse output by the receiver precisely once per second and is used for hardware synchronization.
Activation	Activation refers to a feature added through a one-time purchase. For features that require recurring fees, see Subscription .
Atlas	Atlas is a subscription-based service provided by Hemisphere GNSS.
Base Station	The Base Station is a receiver placed over a familiar point, provides real-time observations, and sends those observations to nearby RTK rovers via UHF radio or the internet.
BeiDou	BeiDou is a global navigation satellite system deployed and maintained by China.
BIN message	Binary message
CAN	Controller Area Network
COG	Course Over Ground – The cardinal direction of travel of the primary antenna. This differs from heading, which is the direction of the vector created from the primary to secondary antenna.
Cold Start	Position moved more than 100km during power-off, or power-off longer than 3 days.
CSEP	This is the distance, in meters, that the receiver has calculated between the primary and secondary antenna. This value should always be accurate to within 2cm.
dB	Decibel. The unit of measurement used to express signal-to-noise ratio (SNR).
DGNSS	Differential GNSS
ESN	Electronic Serial Number

Continued on next page

VS1000 Terms and Definitions, Continued

Terms & definitions,
continued

Term	Definition
Firmware	Firmware is the software loaded into the receiver that controls the functionality of the receiver and runs the GNSS engine.
Galileo	Galileo is a global navigation satellite system deployed and maintained by the European Union and European Space Agency.
GLONASS	Global Orbiting Navigation Satellite System (GLONASS) is a Global Navigation Satellite System deployed and maintained by Russia.
GNSS	Global Navigation Satellite System (GNSS) is a system that provides autonomous 3D position (latitude, longitude, and altitude) and accurate timing globally by using satellites. Current GNSS providers are: GPS, GLONASS and Galileo.
GPS	Global Positioning System (GPS) is a global navigation satellite system deployed and maintained by the United States.
Hot Start	RF signal loss when the power is on.
LED	Light Emitting Diode
MSEP	This is the distance, in meters, between the primary and secondary antenna. This differs from CSEP in that the user measures this value and inputs it into the receiver.
Multipath	Multipath occurs when the GNSS signal reaches the antenna by two or more paths. This causes incorrect pseudo-range measurements and leads to less precise GNSS solutions.
NMEA	National Marine Electronics Association (NMEA) is a marine electronics organization that sets standards for communication between marine electronics.
NTRIP	Networked Transport of RTCM via Internet Protocol – a protocol for transmitting differential GNSS or RTK over the internet.
QZSS	Quasi-Zenith Satellite System (QZSS) is a regional satellite navigation system deployed and maintained by Japan.

Continued on next page

VS1000 Terms and Definitions, Continued

**Terms &
definitions,
continued**

Term	Definition
RF	Radio Frequency
RMS	Root Mean Square
ROX	ROX is a Hemisphere GNSS propriety RTK message format that can be used as an alternative to RTCM3 when both the base and rover are Hemisphere branded.
RTCM	Radio Technical Commission for Maritime Services (RTCM) is a standard used to define RTK message formats so that receivers from any manufacturer can be used together.
RTK	Real-Time-Kinematic (RTK) is a real-time differential GPS method that provides better accuracy than differential corrections.
SBAS	Satellite Based Augmentation System (SBAS) is a system that provides differential corrections over satellite throughout a wide area or region.
SNR	Signal-to-Noise ratio
Warm Start	Power loss is less than cold start time or distance.
WAAS	Wide Area Augmentation System (WAAS) is a satellite-based augmentation system (SBAS) that provides free differential corrections over satellite in parts of North America.

Chapter 1: Introduction

Overview

Introduction This chapter contains the information you need to get started using your VS1000 Vector receiver.

Contents

Topic	See Page
Product Overview	10
Key Features	12
Parts List	13
Firmware Upgrades	14
Using PocketMax to Communicate with the VS1000	18

Product Overview

Product overview

Based on Eclipse™ GNSS technology, the VS1000 is designed for marine applications that require precise heading and RTK position performance from the Vector VS1000 GNSS system.

The VS1000 features a Vector-based receiver and two separate antennas to achieve heading accuracy ranging from 0.01° to 0.17° RMS (depending on the antenna separation) and offers robust positioning performance



Figure 1-1: VS1000 GNSS Receiver

Note: Throughout the rest of this manual the VS1000 GNSS System is referred to as the VS1000.

The standard model VS1000 tracks multi-frequency GPS, GLONASS, BeiDou, Galileo, and QZSS. The VS1000 comes with the ability to add patented Athena RTK technology and can be upgraded via subscriptions to support Atlas L-band.

Continued on next page

Product Overview, Continued

Athena RTK

The VS1000 supports the use of Athena RTK (Real Time Kinematic) technology. Athena RTK requires the use of two separate receivers: a stationary base station (primary receiver) that broadcasts corrections over a wireless link to the rover (secondary receiver). The localized corrections are processed on the rover to achieve superior accuracy and repeatability. Performance testing has shown positioning accuracy at the centimeter level.

Alternatively, RTK corrections can be brought in over a GNSS network (NTRIP) if one is available in your area.

Athena RTK has the following benefits:

- Improved Initialization time - Performing initializations in less than 15 seconds at better than 99.9% of the time.
 - Robustness in difficult operating environments - Extremely high productivity under the most aggressive of geographic environments.
-

Atlas L-band

Atlas L-band corrections are available worldwide. With Atlas, the positioning accuracy does not degrade as a function of distance to a base station, as the data content is not composed of a single base station's information, but an entire network's information.

The VS1000 provides accurate and reliable heading and position information at high update rates. To accomplish this task, the VS1000 uses a high performance GNSS receiver and two antennas for GNSS signal processing.

One antenna is designated as the primary GNSS antenna and the other is the secondary GNSS antenna.

Positions computed by the VS1000 are referenced to the phase center of the primary GNSS antenna. Heading data references the vector formed from the primary GNSS antenna phase center to the secondary GNSS antenna phase center.

Continued on next page

Product Overview, Continued

Atlas L-band, continued

Atlas L-band has the following benefits:

- Positioning accuracy - Competitive positioning accuracies down to 2cm RMS in certain applications.
 - Positioning sustainability - Cutting edge position quality maintenance in the absence of correction signals, using patented technology.
 - Scalable service levels - Capable of providing virtually any accuracy, precision, and repeatability level in the 4 to 50 RMS range.
 - Convergence time - Industry-leading convergence times of 10-40 minutes.
-

Key Features

Key features

Key features of the VS1000 include:

- High-precision positioning in Athena RTK, SBAS, and Atlas L-band
- Athena technology improves RTK performance especially with GLONASS, Galileo, and BeiDou
- Atlas* L-band technology provides highly accurate corrections over the air
- Enhanced connectivity, including Ethernet, USB, CAN, RS-232, and RS-422
- Heave of 30cm RMS (DGNSS), 10cm (RTK)
- Integrated gyro and tilt sensors deliver fast startup times and provides heading updates during temporary loss of GNSS

(*Requires the purchase of a subscription.)

Parts List

VS1000 Parts list

Table 1-1 provides the description and part number of each part in your kit.

Review the parts shipped with your kit. If any parts are damaged, contact your freight carrier. If any parts are missing, contact your dealer.

Table 1-1: Parts list

Part name	Qty	Part Number
VS1000 receiver and mounting bracket	1	752-0029-10
Bluetooth/Wi-Fi Antenna	1	150-0056-10
4.6m power/data cable	1	051-0445-10
10m TNC-TNC RF cable	2	052-0004-000#

Firmware Upgrades

Overview

Periodically, Hemisphere GNSS releases firmware upgrades to improve performance, fix bugs, or add new features to a product. To update the firmware on the VS1000 download the latest version of Hemisphere GNSS RightArm from the following link:

[HTTPS://HGNS.COM/RESOURCES-SUPPORT/SOFTWARE.](https://hgns.com/resources-support/software)

RightArm upgrade

To upgrade your firmware using RightArm, use the following steps:

Table 1-2: RightArm Upgrade

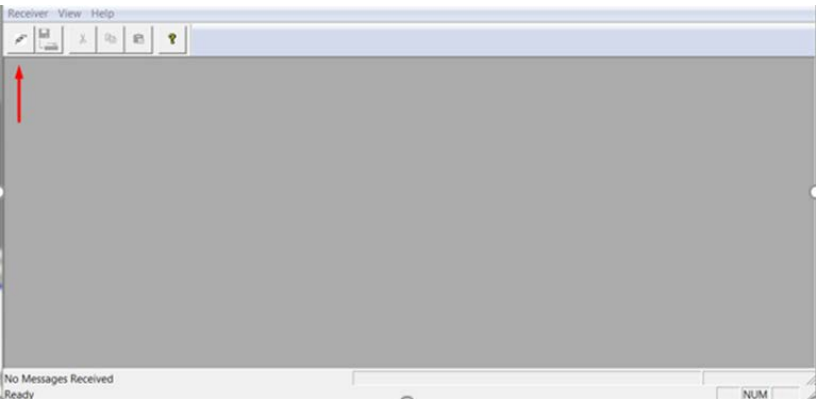
Step	Action
1	<p>Connect the VS1000 to a computer over serial. Firmware can be loaded over either serial port. Set the baud rate of the serial port you are using to 19200.</p> <p>Launch RightArm.</p> <p>Click the Connect button or navigate to Receiver -> Connect.</p> 
2	Choose the COM port connected to the VS1000 and click OK .

Continued on next page

Firmware Upgrades, Continued

RightArm
upgrade,
continued

Table 1-2: RightArm Upgrade (continued)

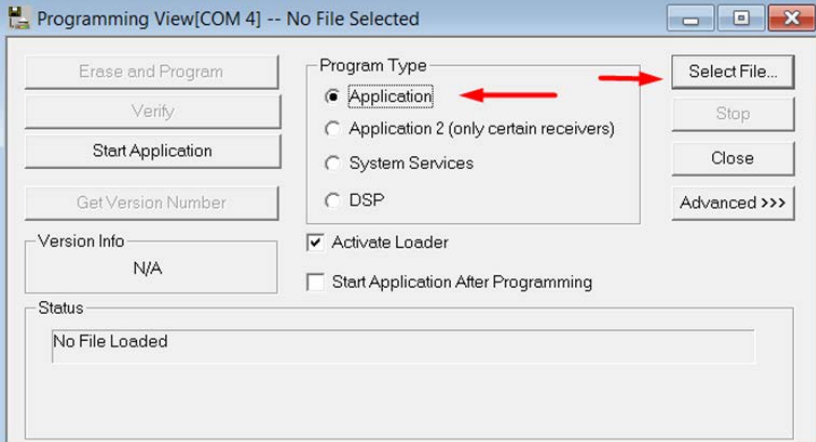
Step	Action
3	<p>Select a Program Type.</p> <p>The VS1000 has two firmware applications, allowing two different versions of GNSS firmware. Hemisphere GNSS suggests loading the new firmware onto both applications.</p> <p>After the firmware update is completed, check the current GNSS firmware.</p> <p>If the current firmware is not the same as the newly loaded firmware, the VS1000 could be using the other application. You can switch applications by sending the following command:</p> <p>\$JAPP,OTHER</p> <p>Choose the Application and press Select File to select the firmware file.</p> 

Continued on next page

Firmware Upgrades, Continued

RightArm
upgrade,
continued

Table 1-2: RightArm Upgrade (continued)

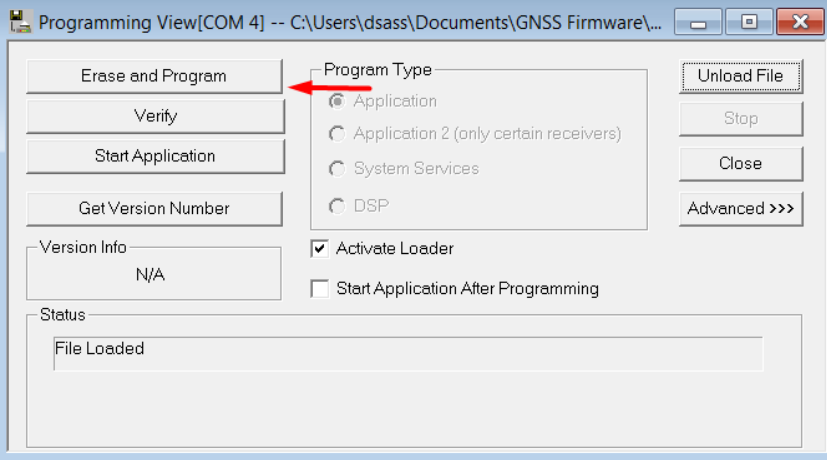
Step	Action
4	<p>Choose the firmware and click Erase and Program.</p> <p>The Activate Loader checkbox in the Programming View window is selected. After pressing the Erase and Program button, this checkbox will de-select, and the Status field indicates the receiver is in loader mode (ready to receive the new firmware file).</p>  <p>Note: If the Activate Loader check box remains selected, power the receiver off and on. When the receiver powers back on, the Activate Loader box should be de-selected.</p> <p>⚠ WARNING: Do not to interrupt the power supply to the receiver, and do not interrupt the communication link between the PC and the receiver until programming is complete. Failure to do so may cause the receiver to become inoperable and will require factory repair.</p>

Continued on next page

Firmware Upgrades, Continued

RightArm
upgrade,
continued

Table 1-2: RightArm Upgrade (continued)

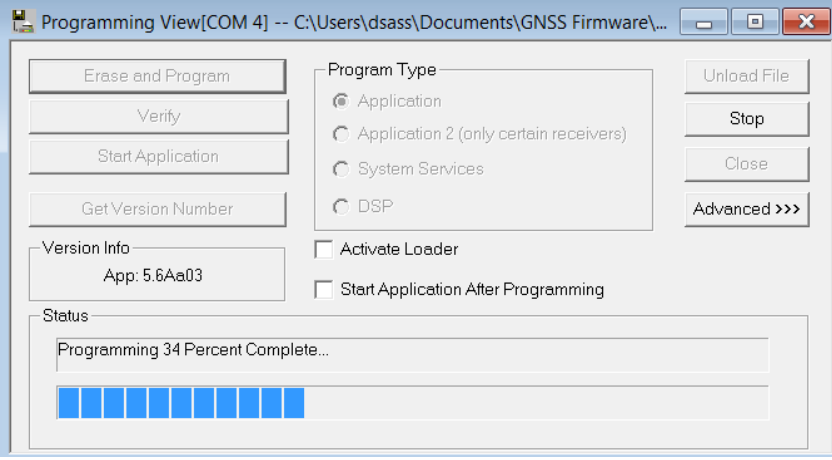
Step	Action
5	 <p>The screenshot shows the 'Programming View[COM 4]' window. It features several buttons: 'Erase and Program', 'Verify', 'Start Application', and 'Get Version Number'. The 'Version Info' section displays 'App: 5.6Aa03'. The 'Program Type' section has radio buttons for 'Application' (selected), 'Application 2 (only certain receivers)', 'System Services', and 'DSP'. There are checkboxes for 'Activate Loader' and 'Start Application After Programming'. On the right, there are buttons for 'Unload File', 'Stop', 'Close', and 'Advanced >>>'. The 'Status' section shows 'Programming 34 Percent Complete...' with a progress bar consisting of 10 blue segments, where the first 4 are filled.</p> <p>Note: After completing the firmware update, Hemisphere GNSS suggests repeating this process for the other application.</p>

Using PocketMax to Communicate with the VS1000

PocketMax

PocketMax is a free utility program that runs on your Windows PC. Simply connect your Windows device to the VS1000 via either serial or CAN (PEAK and Kvaser CAN adapters are supported), and open PocketMax.

The screens within PocketMax allow you to easily interface with the VS1000 to:

- Configure the VS1000 to receive RTK over a serial port, or to use Atlas L-band as a correction source
 - Configure GNSS message output and port settings
 - Review heading, pitch, and roll visually
 - Help calculate heading offset or heading bias
-

Chapter 2: Installing the VS1000

Overview

Introduction This chapter describes the steps and equipment needed to install the VS1000.

Contents

Topic	See Page
System Orientation	20
Mounting the Antennas	21
A45 Antenna	22
Routing and Securing the Antenna Cable	25
Mounting the VS1000	27
Dimensions	33
Connectors	34
Connecting the Receiver to External Devices	35
Power Considerations	36

System Orientation

System orientation

When installing the VS1000, if pitch and roll values from the VS1000 are to be used, consider the orientation of the VS1000 with respect to the antennas, since GNSS can only provide one axis and the other axis must come from an inertial sensor.

If gyro-aiding is to be used, consider the orientation of the VS1000 with respect to the antennas.

Orientation of the VS1000 with respect to the antennas must be configured while the VS1000 is on a level surface (parallel to the mounting surface), since this configuration will calibrate the internal sensor and set values to zero.

It is recommended to apply these settings and verify the surface is level in the shop (rather than on a vessel) prior to installation.

Mounting the Antennas

Parallel Antenna orientation

The most common installation is to orient the antennas parallel to, and along the centerline of, the axis of the vessel with the primary antenna near the stern and the secondary antenna near the bow. This provides a true heading, since heading is calculated from the primary to secondary antenna. If the primary antenna is near the bow and secondary antenna near the stern, you will need a heading bias of approximately 180°.

In this orientation, you may need to enter a small heading bias in the VS1000 to calibrate the physical heading to the true heading of the vessel.

Perpendicular Antenna orientation

You can also install the antennas so they are oriented perpendicular to the centerline of the vessel's axis.

In this orientation, you will need to enter a heading bias of +90° if the primary antenna is on the star side of the vessel, and -90° if the primary antenna is on the port side of the vessel.

Planning the optimal antenna placement

Proper antenna placement is critical to positioning accuracy. For the best results, orient the antennas so the antennas' connectors face the same direction. Place the antennas with a clear view of the horizon, away from other electronics and antennas, and along the vessel's centerline.

When mounting the primary and secondary antennas, consider the following:

- The recommended minimum separation is 0.5m.
 - The maximum separation is 10.0m if the receiver has a multi-frequency activation. If the receiver is only activated for single frequency, the maximum separation is 5.0m.
 - The position is calculated from the primary antenna.
 - Maintain at least 25cm distance from transmitting radios/antennas, as they may interfere with GNSS.
 - Maintain a clear view of the sky, avoiding metal obstructions at a higher elevation than the antenna (when possible).
-

A45 Antenna

A45 phase center measurements

The phase center measurements for the A45 antenna is important when using an RTK positioning solution. Figure 2-1 shows the phase center measurements.

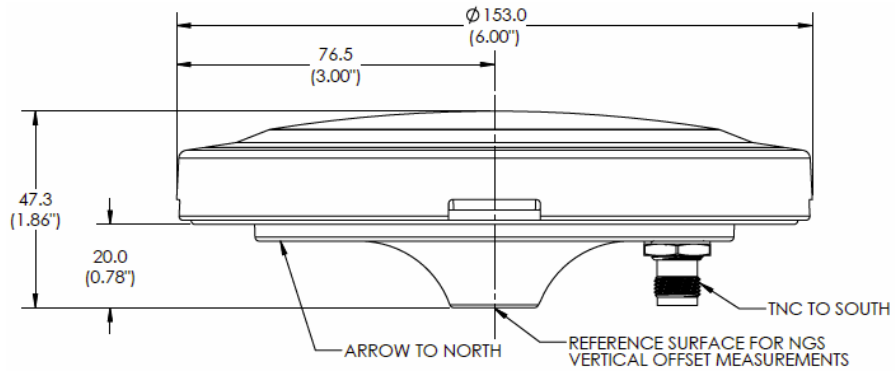

Figure 2-1: Phase center measurements

Continued on next page

A45 Antenna, Continued

A45 antenna alignment

An arrow on the bottom of the A45 indicates the forward-facing direction for heading, and the marks on the side of the A45 allow you a “zero” point for measuring the height of the antenna for the surface on which it is mounted. The height is relative to the accuracy of the RTK solution. Figure 2-2 shows the A45 arrow and alignment marks.

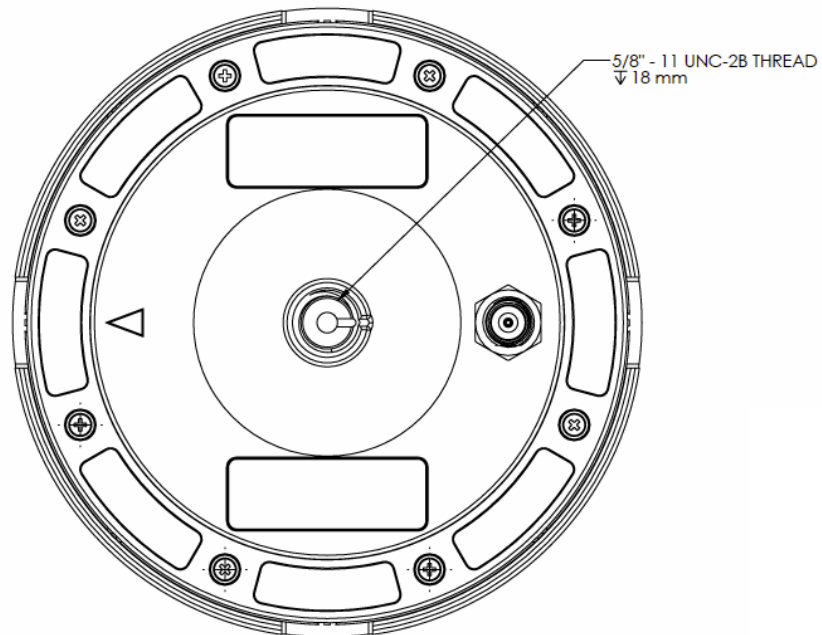

Figure 2-2: A45 arrow and alignment marks

Continued on next page

A45 Antenna, Continued

**Alignment
when using Two
A45 antennas**

The arrows for the two A45 antennas should both be facing the same direction (to within 2 degrees). There is no need to align the A45 antennas with the VS1000. Figure 2-3 shows the A45 alignment.

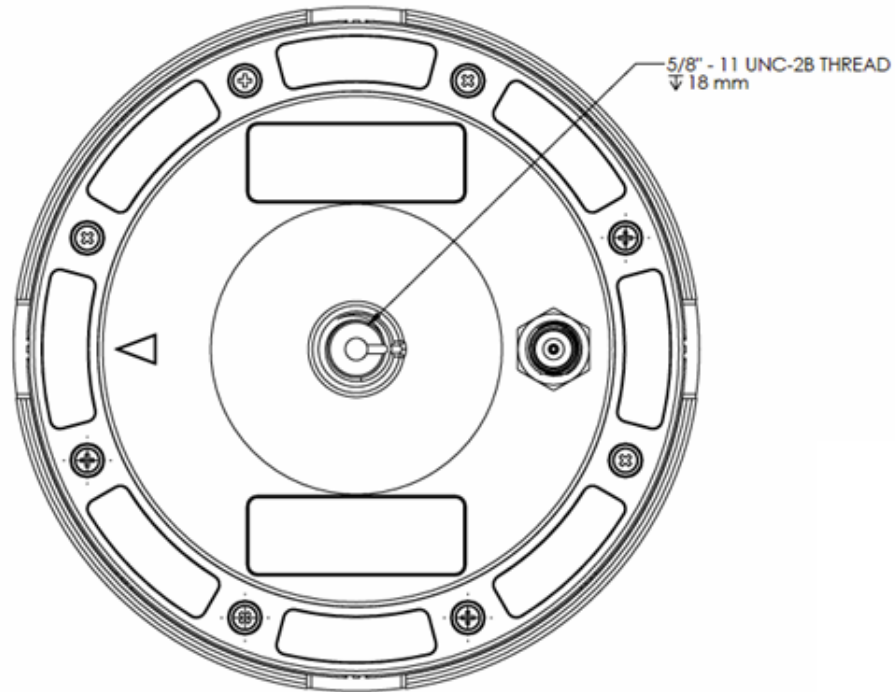

Figure 2-3: A45 alignment (bottom view)

**Alignment
when using A45
antenna**

There is no need to align the A45 antenna with the VS1000.

Routing and Securing the Antenna Cable

Routing and securing the antenna cable

To route and secure the antenna cables, review the following guidelines. We recommend the following HGNSS antenna cables:

- 052-0004-000# 10m TNC-TNC antenna cable
- 052-0005-000# 5m TNC-TNC antenna cable
- 050-0019-001# 30m Low-loss TNC-TNC antenna cable

If you choose to use different cables, each A45 antenna requires a 50 Ω impedance antenna extension cable, such as RG-58U (up to a maximum of 15 m (49 ft.) in length), for proper operation.

The GNSS receiver inside the VS1000 requires a minimum input gain of 10 dB (and maximum of 40 dB before saturation will occur). The antennas offer 28 dB of gain, so the loss budget to accommodate for cable losses is 18 dB.

Regardless of the cable material and length you choose, ensure the cable losses are less than 18 dB of attenuation. Due to variances in the antenna gain and practical attenuation of cable materials and connectors, we recommend reducing this budget to 15 dB; this budget is present to overcome the resulting attenuation of an RF cable.

When deciding on an antenna location, consider the amount of cable required: a longer cable of the same material will result in a higher loss than a shorter one. If the overall loss of the longer cable exceeds 15 dB, change the cable material (this normally means a more expensive material that has a larger diameter and less flexibility).

Continued on next page

Routing and Securing the Antenna Cable, Continued

Routing and securing the antenna cable, continued

RF cables are required to meet the minimum qualification presented below (based on a maximum length of 30m/100ft.):

- Impedance: 50 +/- 2 Ohm
- Attenuation: <15 dB/100 ft @ 1.5GHz
- Resistance: <1.9 Ohm/100 ft
- Insertion Loss: <5 dB @ 1.5GHz
- Min. Bending Radius: 50mm
- Temperature Range
- Operating: -65° to +165° C
- Installation: -25°C to +70°C

⚠ WARNING:
The VS1000 receiver provides 5 VDC across the antenna ports. Connection to incompatible devices may damage equipment.

Table 2-1 provides a summary of readily available cable materials with 50 Ω impedance.

Table 2-1: Cable losses (not including connector losses)

Material	Loss at GPS (1.575 GHz)
RG58	0.78 dB/m
RG8	0.36 dB/m
Times Microwave LMR400	0.15 dB/m

Mounting the VS1000

Introduction This section provides information on mounting the VS1000 in the optimal location, orientation considerations, environmental considerations, and other mounting options.

GNSS satellite reception When considering where to mount the VS1000, consider the following satellite reception recommendations:

- Ensure cable length is adequate to route into the machine to reach a breakout box or terminal strip.
- Do not mount the receiver where environmental conditions exceed those specified in the technical specifications of this document.
- Route cables away from any potential source of mechanical damage. Do not locate the antenna where environmental conditions exceed those specified in [Appendix A, Technical Specifications](#) of this document.

Environmental considerations Hemisphere Vector GNSS receivers are designed to withstand harsh environmental conditions; however, adhere to the following limits when storing and using the VS1000:

- Operating temperature: -40°C to +70°C (-40°F to +158°F)
- Storage temperature: -40°C to +85°C (-40°F to +185°F)
- Humidity: IEC 16750-4:2010 Section 5.6 Humid heat, cyclic test

Mounting options The VS1000 allows for two different mounting options: mount with bolts, or mount with magnets.

Continued on next page

Mounting the VS1000, Continued

Power/Data cable considerations

Before mounting the VS1000, consider the following regarding power/data cable routing:

Do	Do not
Ensure cable reaches appropriate power source.	Run cables in areas of excessive heat.
Keep cable away from corrosive chemicals.	Run cables through a door or window jams.
Connect to a data storage device, computer, or other device that accepts GNSS data.	Crimp or excessively bend the cable.
Keep cable away from rotating machinery.	Place tension on the cable.
Remove unwanted slack from the cable at the VS1000 end.	
Secure along the cable route using plastic tie wraps.	

⚠ WARNING:

Improperly installed cable near machinery can be dangerous.

Connecting the Serial Power/Data cable

To connect the serial power and data cable:

1. Align the cable connector key-way with the VS1000 connector key.
2. Push the connector in until it locks. The locking action is firm; you will feel a positive “click” when it has locked.

⚠ WARNING:

Do not apply a voltage higher than 36 VDC. This will damage the receiver and void the warranty. Also, do not attempt to operate the VS1000 with the fuse bypassed, as this will void the warranty.

Continued on next page

Mounting the VS1000, Continued

Mounting orientation

If using pitch and roll values from the VS1000, you will need to configure the orientation of the receiver with respect to the antennas. You will do this by sending three commands to the receiver:

1. \$JATT,ACC90,YES or \$JATT,ACC90,NO
2. \$JATT,ACC180,YES or \$JATT,ACC180,NO
3. \$JATT,TILTCAL

When you send **\$JATT,TILTCAL**, the pitch and roll values from the internal sensor will zero. **This should only be sent when the receiver is parallel to the mounting surface.**

If the ACC90 and ACC180 values are not to be configured, then pitch and roll from the receiver should be ignored, GYROAID should be turned off (**\$JATT,GYROAID,NO**) and TILTAID should be turned off (**\$JATT,TILTAID,NO**).

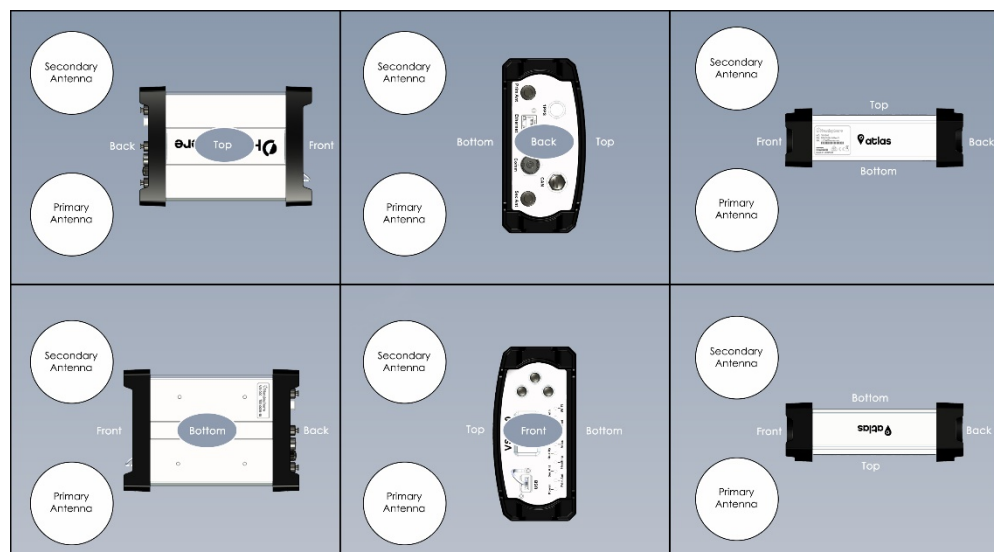

\$JATT,ACC90,NO
\$JATT,ACC180,NO

Figure 2-4: Group A

Continued on next page

Mounting the VS1000, Continued

Mounting orientation, continued

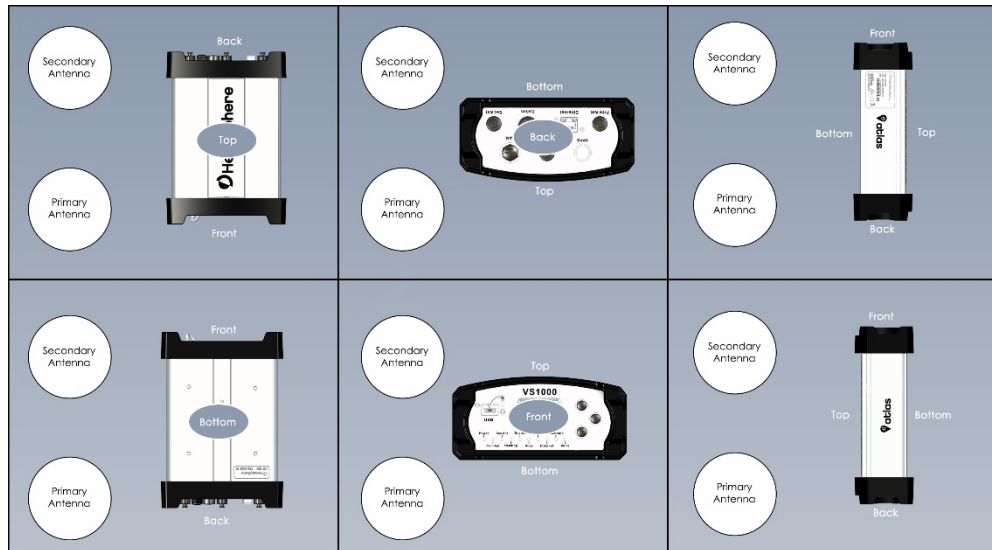

\$JATT,ACC90,YES
\$JATT,ACC180,NO

Figure 2-5: Group B

Continued on next page

Mounting the VS1000, Continued

Mounting orientation, continued

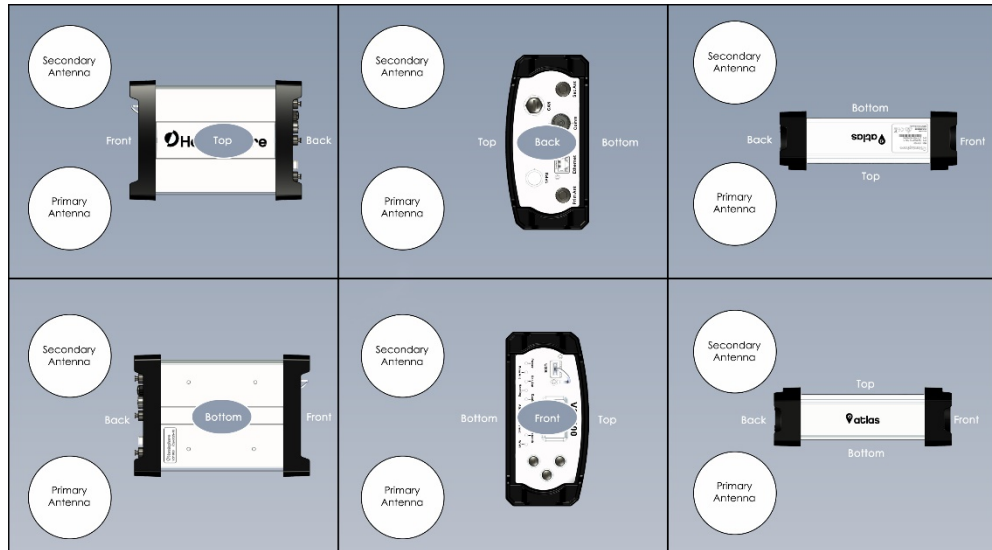

\$JATT,ACC90,NO
\$JATT,ACC180,YES

Figure 2-6: Group C

Continued on next page

Mounting the VS1000, Continued

Mounting orientation, continued

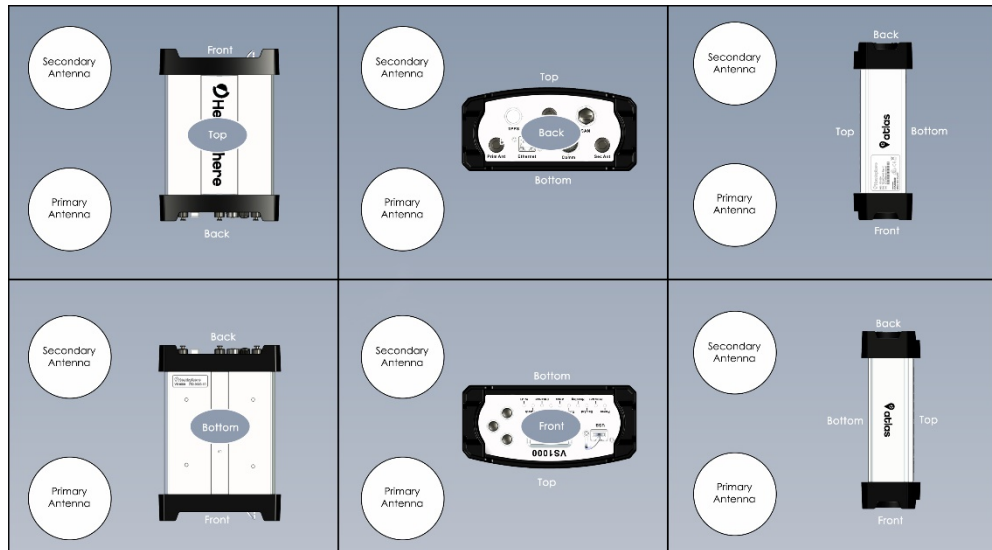

\$JATT,ACC90,YES
\$JATT,ACC180,YES

Figure 2-7: Group D

Dimensions

VS1000 dimensions

Figures 2-8 shows the dimensions of the VS1000.

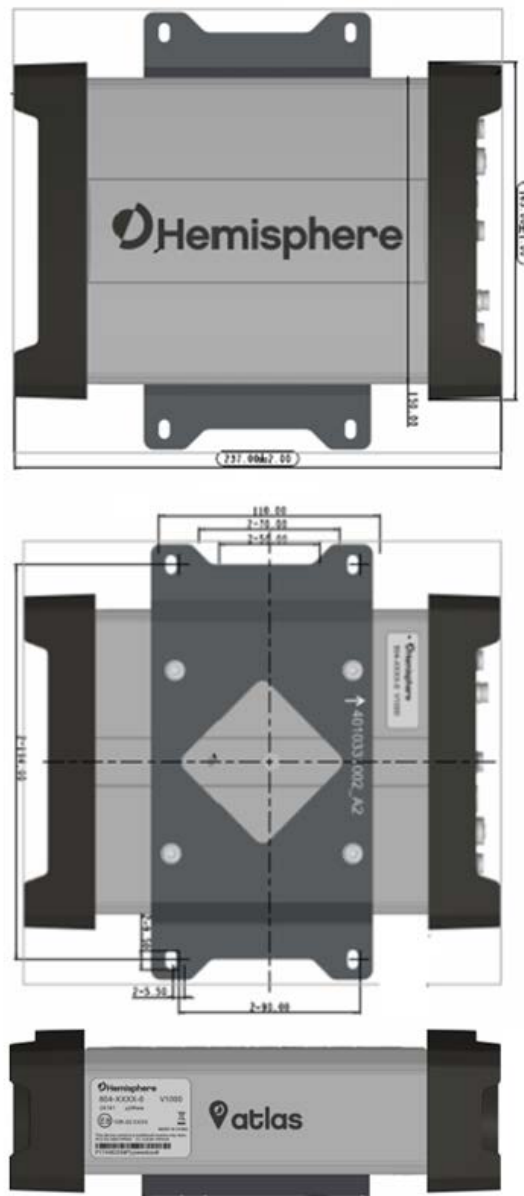

Figure 2-8: VS1000 dimensions

Connectors

Connectors The VS1000 has seven connectors on the back panel.

Table 2-2: VS1000 connectors

Connector	Connector (Label)	Type	Purpose
1	1PPS	BNC	Connect the external GNSS antenna here.
2	BT/Wi-Fi	TNC	Connect the external BT/Wi-Fi antenna here.
3	CAN (M)	Molex 5-pin Ultra-Lock	Use this connector to power the unit and to communicate with the VS1000 over CANbus.
4	Prim Ant	TNC	Connect the Primary GNSS antenna coaxial cable here.
5	Ethernet	RJ45	Connect the Ethernet CAT-5 cable here.
6	Comm	12-pin (F)	Connect for power, 1PPS, event marker, and RS232/RS422 communication.
7	Sec Ant	N-Type (F)	Connect the Secondary GNSS antenna coaxial cable here.

Connecting the Receiver to External Devices

Connect to external devices

You can connect the VS1000 to external devices via the CAN and Comm connectors.



Figure 2-9: VS1000 port connections

The default baud rates, NMEA message types, and update rates for both ports are listed in “Default Parameters”. If the NMEA data messages you desire are different from the default values, you can select those messages. Use the Config Wizard to select your NMEA message types and update rates per port.

Power Considerations

Power considerations

Figures 2-10 thru 2-11 show the port pin-outs and Tables 2-3 thru 2-4 provide the pin-out specifications.

Note: The “Pin” column in Tables 2-3 thru 2-4 refers to the pin assignments located on the VS1000. All pins on the mating connector are mirrored.



Figure 2-10: 5-pin (male) CAN port pin-out

Table 2-3: 5-pin (male) CAN port pin-out

Pin	Description
1	Shield
2	Power In
3	Power Ground
4	CAN Hi
5	CAN Lo

Continued on next page

Power Considerations, Continued

Power/data
connector

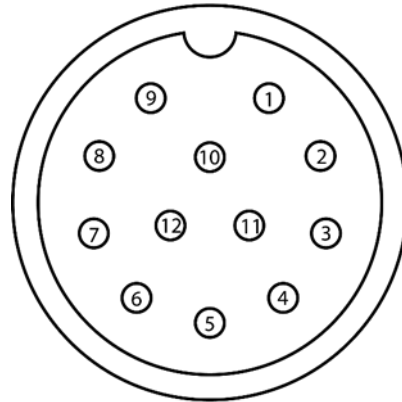

Figure 2-11: 12-pin power/data port pin-out

Power/data
connector,
continued

Table 2-4: 12-pin power/data port pin-out

Pin	Description	Color
1	Event marker in / 1PPS out	White
2	RS-232 Port B Tx / RS-422 Port B Tx-	Brown
3	RS-232 Port B Rx / RS-422 Port B Rx+	Blue
4	RS-422 Port B Tx+	Orange
5	Isolated (Port B) Ground	Yellow
6	RS-232 Port A Tx	Violet
7	RS-232 Port D Tx*	Gray
8	RS-232 Port A Rx	Pink
9	RS-422 Port B Rx-	Tan
10	12v Power In	Red
11	Power/Digital Ground	Black
12	RS-232 Port D Rx*	Green
* Limited functionality		

Continued on next page

Power Considerations, Continued

Power/data
connector,
continued,
continued

⚠ WARNING:

Pin 10 (12v Power In) on the 12-pin Power/data connector is directly connected internally to Pin 2 (Power In) on the 5-pin CAN connector. Provide power to the VS1000 on only one of these two connectors.

Serial port
configuration

You may configure Port A or Port B of the GNSS receiver to output any combination of data.

Port A can have a different configuration from Port B in data message output, data rates, and the baud rate of the port, and configure the ports independently based upon your needs.

Note: For successful communications, use the 8-N-1 protocol and set the baud rate of the VS1000's serial ports to match that of the devices to which they are connected. Flow control is not supported.

Baud Rates &
Message Types

When selecting your baud rate and message types, use the following formula to calculate the bits/sec for each message and sum the results to determine the baud rate for your required data throughput.

Message output rate * Message length (bytes) * bits in byte = Bits/second
(1 character = 1 byte, 8 bits = 1 byte, use 10 bits/byte to account for overhead).

For information on message output rates refer to the [Hemisphere GNSS Technical Reference Manual](#).

Chapter 3: Operating the VS1000

Overview

Introduction Chapter 3 provides the information you need to power and operate your VS1000 receiver.

Contents

Topic	See Page
Powering the Receiver On/Off	40
Configuring the VS1000 Using the WebUI (Bluetooth/Wi-Fi)	42
Configuring the VS1000 Using the WebUI (Ethernet)	64
Common Commands and Messages	83

Powering the Receiver On/Off

Powering the receiver on/off

The VS1000 powers on automatically when it receives 8 – 36 VDC. The “Power” LED on the front panel illuminates green when the receiver has power.

The VS1000 accepts an input voltage of 8 to 36 VDC via the power cable. The supplied power should be continuous and clean for best performance.

⚠ WARNING:

Do not apply a voltage higher than 36 VDC. The VS1000 is protected from a reversed power connection. A 3-Amp power fuse is recommended for the protection of personnel and the system.

Although the VS1000 proceeds through an internal startup sequence when you apply power, it will be ready to communicate immediately.

Initial startup may take 5 to 15 minutes depending on the location. Subsequent startups will output a valid position within 1 to 5 minutes depending on the location and time since the last startup.

To power on the VS1000, connect the ends of the VS1000 power cable to a clean power source providing 8 to 36 VDC.



Figure 3-1: LED indicators

Continued on next page

Powering the Receiver On/Off, Continued

Powering the receiver on/off, continued

Table 3.1: LED Indicators

LED	Color(s) & Functions
Power	Solid GREEN indicates receiver is powered on
Prim Ant	Solid GREEN indicates tracking 4+ satellites Solid RED indicates no satellites
Sec Ant	Solid GREEN indicates tracking 4+ satellites Solid RED indicates no satellites
Heading	Solid GREEN indicates 2D GNSS heading Solid AMBER indicates 2D sensor heading
Quality	Solid GREEN indicates selected corrections fixed Flashing GREEN indicates DGPS is operational (SBAS, Atlas) Solid AMBER indicates autonomous Solid RED indicates no satellites
Atlas	Solid GREEN indicates Atlas locked Solid AMBER indicates Atlas activated but not locked
CAN	Solid GREEN indicates CAN enabled Flashing GREEN (1/sec) indicates CAN in use
Ethernet	Solid GREEN indicates Ethernet enabled Flashing GREEN (1/sec) indicates Ethernet in use
Bluetooth	Solid BLUE indicates BT enabled Flashing BLUE (1/sec) indicates BT in use
Wi-Fi	Solid GREEN indicates Wi-Fi enabled Flashing GREEN (1/sec) indicates Wi-Fi in use

Configuring the VS1000 Using the WebUI (Bluetooth/Wi-Fi)

Overview

The VS1000 is equipped with an onboard WebUI.

Note: The VS1000 WebUI supports Chrome and Firefox web browsers.

First, connect the Bluetooth/WiFi antenna to the connector. The receiver displays as an available Wi-Fi device in your available networks. Connect your device to the VS1000's Wi-Fi. The password is hgns1234.

Open a web browser window and type the following IP address:
192.168.100.1

Status tab

The VS1000 **Status** tab displays Receiver, Position, Heading, Precision, Solution Status, and L-band/SBAS information.

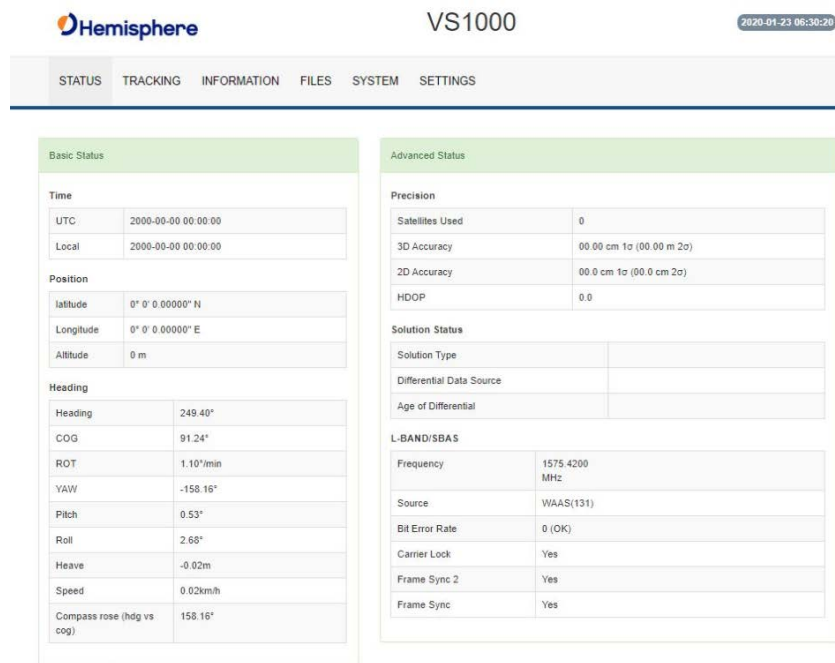

The screenshot shows the VS1000 WebUI interface. At the top, there is a navigation bar with tabs: STATUS, TRACKING, INFORMATION, FILES, SYSTEM, and SETTINGS. The 'STATUS' tab is selected. Below the navigation bar, there are two main sections: 'Basic Status' and 'Advanced Status'.

Basic Status

Time	
UTC	2000-00-00 00:00:00
Local	2000-00-00 00:00:00

Position

Latitude	0° 0' 0.00000" N
Longitude	0° 0' 0.00000" E
Altitude	0 m

Heading

Heading	249.40°
COG	91.24°
ROT	1.10°/min
YAW	-158.16°
Pitch	0.53°
Roll	2.68°
Heave	-0.02m
Speed	0.02km/h
Compass rose (hdg vs cog)	158.16°

Advanced Status

Precision	
Satellites Used	0
3D Accuracy	00.00 cm 1σ (00.00 m 2σ)
2D Accuracy	00.0 cm 1σ (00.0 cm 2σ)
HDOP	0.0

Solution Status

Solution Type	
Differential Data Source	
Age of Differential	

L-BAND/SBAS

Frequency	1575.4200 MHz
Source	WAAS(131)
Bit Error Rate	0 (OK)
Carrier Lock	Yes
Frame Sync 2	Yes
Frame Sync	Yes

Continued on next page

Configuring the VS1000 Using the WebUI (Bluetooth/Wi-Fi), Continued

Status tab tab,
continued

Table 3-2: Status fields

Field	Description
Time	UTC time obtained from satellites; Local time configured in Settings; Miscellaneous tab
Position	Latitude, Longitude, Altitude
Heading	Heading, COG, ROT, YAW, pitch, roll, heave, speed, and the difference between heading and COG
Precision	Satellites used in solution, 3D Accuracy, 2D Accuracy, horizontal dilution of precision
Solution Status	Solution type, correction source, correction signal latency
L-band /SBAS	Atlas Frequency, Source, Bit Error Rate, Carrier Lock, DSP Lock, Frame Sync, Frame Sync 2*

***Note:** For a definition of the L-band/SBAS fields refer to [VS1000 Terms and Definitions](#) in this document.

Continued on next page

Configuring the VS1000 Using the WebUI (Bluetooth/Wi-Fi), Continued

Tracking tab On the **Tracking** tab, the Sky Plot shows the azimuth, elevation, and SNR values of all tracked satellites.

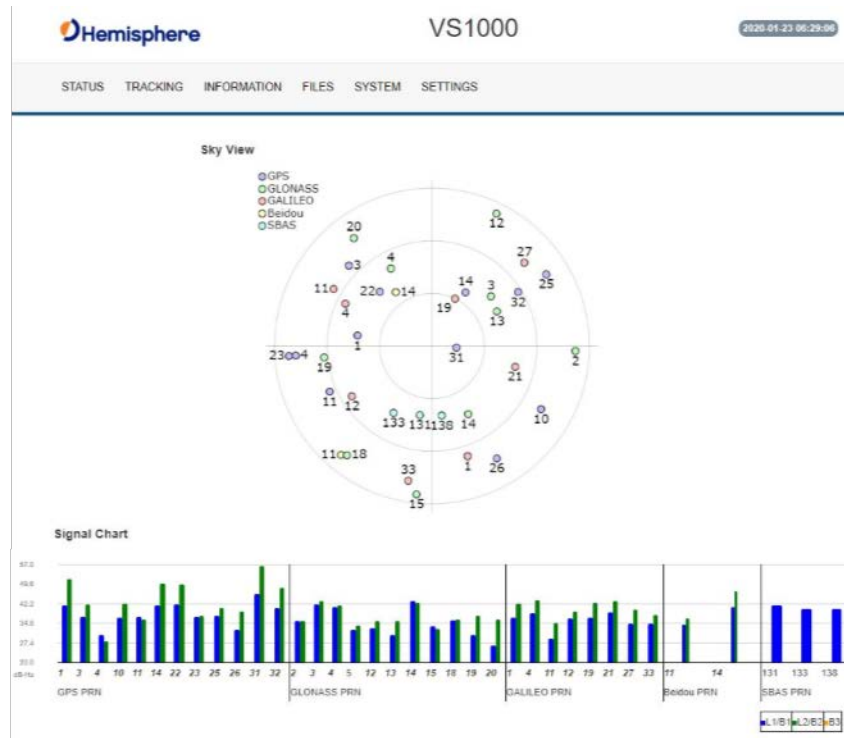

Continued on next page

Configuring the VS1000 Using the WebUI (Bluetooth/Wi-Fi), Continued

Information tab On the **Information** tab, the Serial Number, Board Type, Board Firmware, Subscriptions, Devices, RX info, and Port information is displayed.

Activated items are in green.

Device information is listed in the bottom portion of the **Information** tab. Click on each tab for information related to Serial, CAN and Network.

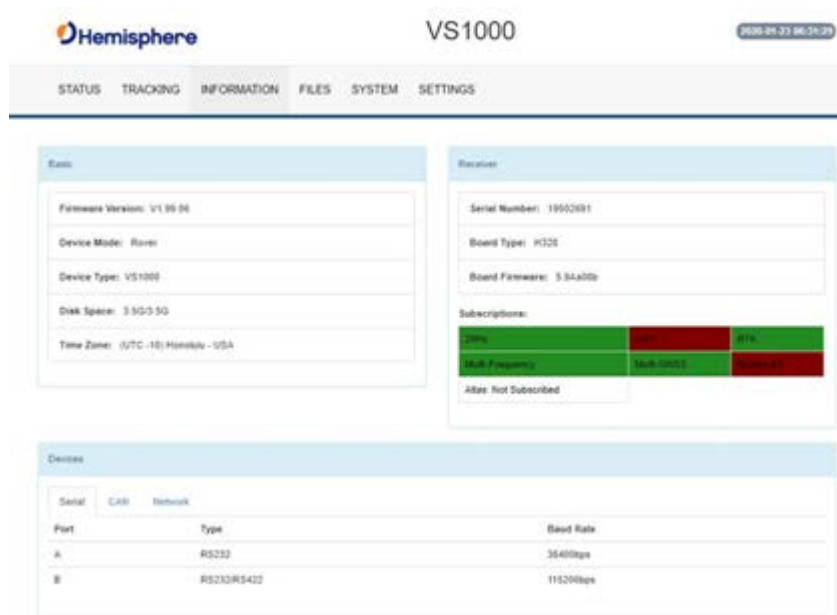

The screenshot shows the VS1000 WebUI interface. At the top, there is a navigation bar with tabs: STATUS, TRACKING, INFORMATION (selected), FILES, SYSTEM, and SETTINGS. The main content area is divided into three sections:

- Basic:** Displays Firmware Version: V1.99.04, Device Mode: Rover, Device Type: VS1000, Disk Space: 3.9G/3.9G, and Time Zone: (UTC-10) Honolulu - USA.
- Receiver:** Displays Serial Number: 19902891, Board Type: R32E, and Board Firmware: 5.8Aa00b. It also shows a Subscriptions section with a table:

Subscription	Status
GPS	ON
Multi-Constellation	ON
RTK	OFF
Multi-Frequency	ON
RTK Correction	OFF

 Below this is a field for Alias: Not Subscribed.
- Devices:** A table showing port information:

Port	Type	Baud Rate
A	RS232	38400bps
B	RS232/RS422	115200bps

Below is the **CAN** tab:



The screenshot shows the VS1000 WebUI interface with the 'Devices' tab selected. The 'CAN' sub-tab is active, displaying a table with the following data:

Channel	Status	Baud Rate
CAN 1	ON	250K bps

Continued on next page

Configuring the VS1000 Using the WebUI (Bluetooth/Wi-Fi), Continued

Information
tab, continued

Below is the **Network** tab:



Devices		
Serial	CAN	Network
WiFi Name:	vs1000_19502691	LT
WiFi Key:	<input type="password"/>	
Bluetooth Name:	vs1000_19502691	LT
Bluetooth PIN:	<input type="password"/>	

Continued on next page

Configuring the VS1000 Using the WebUI (Bluetooth/Wi-Fi), Continued

Files tab

Use the **Files** tab to upload files and download log files from the receiver.

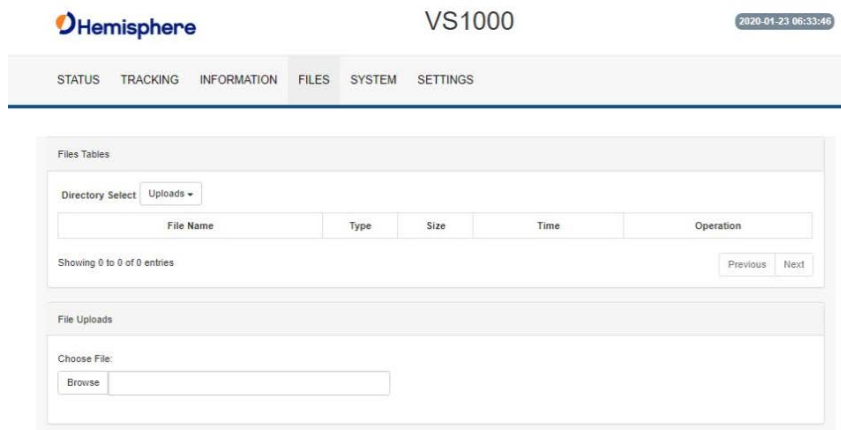

To install firmware, use the following steps:

1. Click **Browse** and choose a file to upload. The uploaded files display.
2. Next to **Directory Select**, click the dropdown arrow to select from **Uploads** (your uploaded files) and **Logs** (log files).
3. Next to each filename is the filetype (e.g. carrier firmware or GNSS firmware), size, time of upload, and operation. Click the down arrow to download the file or Click **X** to delete the file.
4. Click the downward facing arrow to install the firmware file.

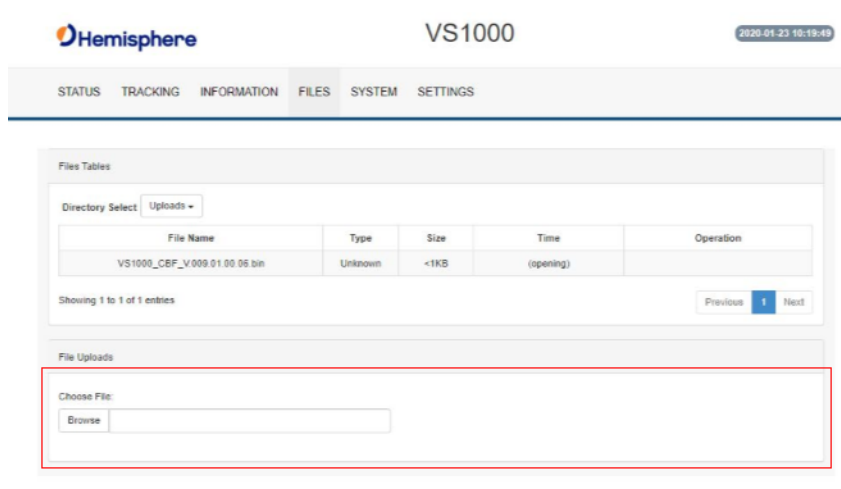

Continued on next page

Configuring the VS1000 Using the WebUI (Bluetooth/Wi-Fi), Continued

Files tab
(continued)

To confirm the firmware install, review the information in the red-highlighted section below.

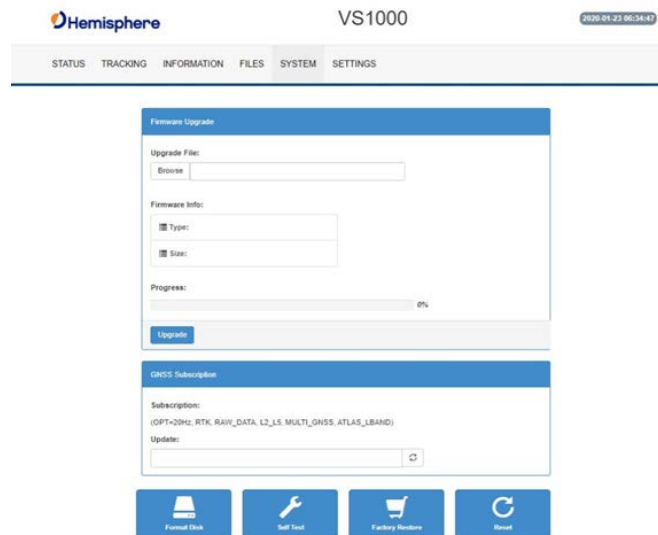
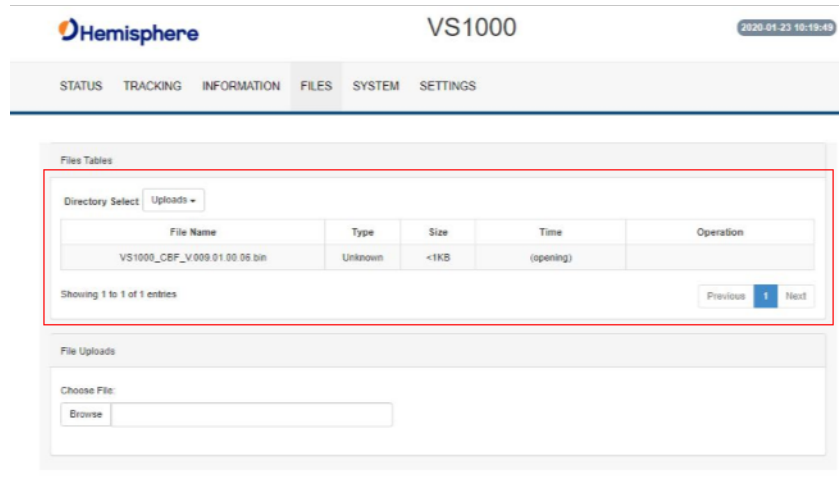

Note: The filesystem cannot be used when Bluetooth is enabled. If Bluetooth is enabled, an option will be given to disable Bluetooth.

Continued on next page

Configuring the VS1000 Using the WebUI (Bluetooth/Wi-Fi), Continued

System tab

The **System** tab can be used to upgrade GNSS firmware or carrier board firmware. You can also add subscription codes on this screen.

Use the buttons at the bottom of the screen:

- **Format Disk**-format the internal storage
- **Self Test**-run a receiver self-test
- **Factory Restore**-restore the unit to factory settings
- **Reboot**-reboot the unit

After Bluetooth is disabled, the filesystem displays. Any log files stored on the receiver will be available for download.

To upgrade firmware, click **Choose File**, select the GNSS or carrier board firmware, and press **Upload**.

Important: If you have purchased an activation or subscription, use the field on the **System** tab to enter the Subscription Code, and click the 'arrows' button.

Continued on next page

Configuring the VS1000 Using the WebUI (Bluetooth/Wi-Fi), Continued

Settings

A pop-up dialog box displays prompting for username and password. Type the UserName **admin** and the password **Hemi3384**.

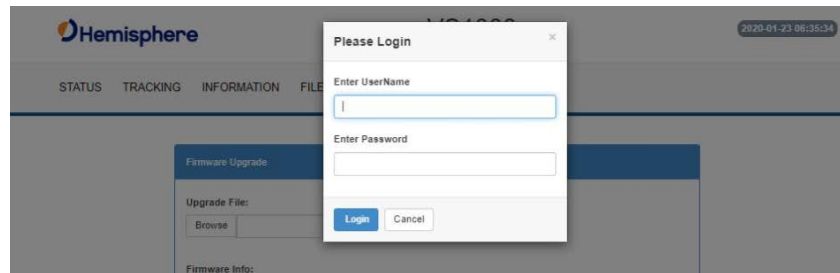

You can configure the following menus using the VS1000 WebUI:

- Heading
- CAN
- Serial
- WLAN
- Logging
- Atlas
- Miscellaneous

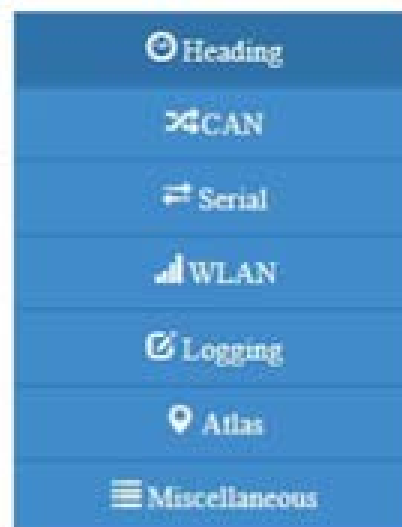

Continued on next page

Configuring the VS1000 Using the WebUI (Bluetooth/Wi-Fi), Continued

Heading menu The **Heading** menu displays the various heading settings, which can also be configured.

Click the box of the desired setting and type the configuration setting values.

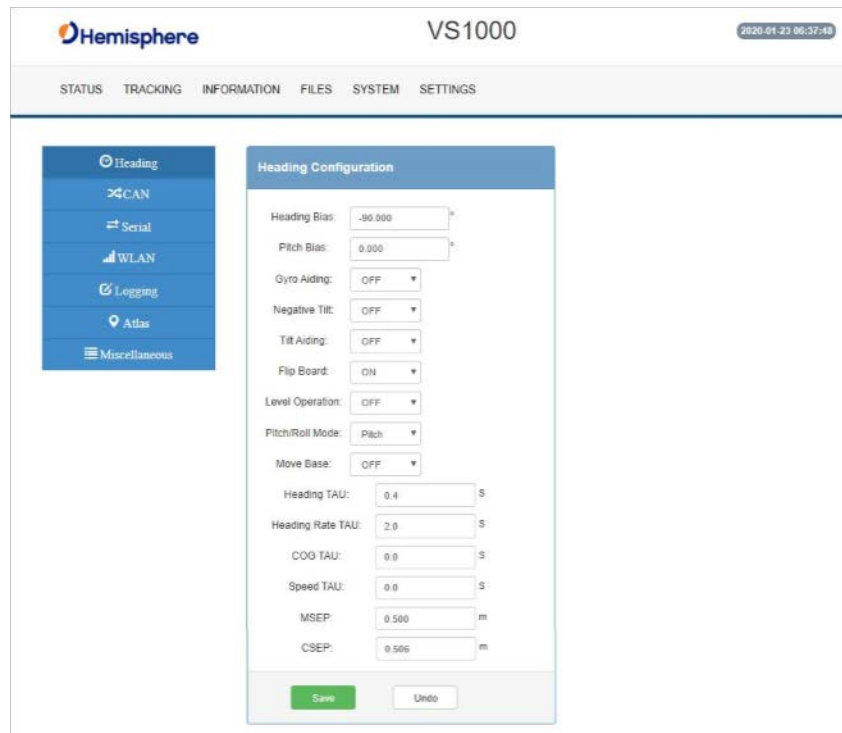

The screenshot displays the Hemisphere VS1000 WebUI interface. At the top, the Hemisphere logo and 'VS1000' are visible, along with a timestamp '2020-01-23 06:37:48'. A navigation bar includes 'STATUS', 'TRACKING', 'INFORMATION', 'FILES', 'SYSTEM', and 'SETTINGS'. A left sidebar contains menu items: 'Heading', 'CAN', 'Serial', 'WLAN', 'Logging', 'Atlas', and 'Miscellaneous'. The main content area is titled 'Heading Configuration' and contains the following settings:

Heading Bias:	-90.000	s
Pitch Bias:	0.000	s
Gyro Aiding:	OFF	
Negative Tilt:	OFF	
Tilt Aiding:	OFF	
Flip Board:	ON	
Level Operation:	OFF	
Pitch/Roll Mode:	Pitch	
Move Base:	OFF	
Heading TAU:	0.4	s
Heading Rate TAU:	2.0	s
COG TAU:	0.0	s
Speed TAU:	0.0	s
MSEP:	0.500	m
CSEP:	0.500	m

At the bottom of the configuration panel are 'Save' and 'Undo' buttons.

Continued on next page

Configuring the VS1000 Using the WebUI (Bluetooth/Wi-Fi), Continued

Heading menu, continued **Table 3-3: Heading Configurations**

Heading Configuration	Description
Heading Bias	<p>Add a bias to the heading value the receiver outputs. Heading is defined as the direction of the vector created from the primary to secondary antenna. Heading is measured using true north.</p> <p>Range: -180 – +180</p>
Pitch Bias	<p>Add a bias to the pitch value the receiver outputs. If the receiver is in “roll” mode, this will add a bias to the roll instead.</p> <p>Range: -15 – +15</p>
Gyro Aiding	<p>Gyro Aiding enables the use of the internal gyro sensor and allows for the continuous output of heading for up to three minutes during a GNSS outage. Gyro Aiding improves the reacquisition time when GNSS Heading is lost because of an obstruction in GNSS signal.</p>
Negative Tilt	<p>Change the sign of the pitch/roll measurement.</p>
Tilt Aiding	<p>Turn OFF or ON Tilt Aiding. When on, the sensors are used to reduce the RTK search volume – improving heading start up and reacquisition times.</p>
Flip Board	<p>N/A</p>
Level Operation	<p>If the Vector will be operated within +/- 10 degrees of level, you may use this mode of operation for increased robustness and faster acquisition times of the heading solution.</p>

Continued on next page

Configuring the VS1000 Using the WebUI (Bluetooth/Wi-Fi), Continued

Heading menu,
continued,
continued

Table 3-3: Heading Configurations (continued)

Heading Configuration	Description
Pitch/Roll Mode	<p>If the antennas are mounted such that they model pitch, set to PITCH.</p> <p>If the antennas are mounted such that they model roll, set to ROLL.</p> <p>Note: If your HBIAS is -90 or +90, set this to ROLL. If your HBIAS is 0 or 180, set this to PITCH.</p>
Heading TAU	<p>Adjust the responsiveness to true heading.</p> <p>If the machine is large and unable to turn quickly, increase this value.</p> <p>For longer baselines (10 m) HTAU should be between 0.1 and 0.5, since the gyro introduces noise.</p> <p>Default value: 0.1s with gyro enabled Range: 0.0 to 60s Formula: $htau (s) = 40 / \text{max rate of turn } (^\circ/s)$ <i>with gyro ON</i> $htau (s) = 10 / \text{max rate of turn } (^\circ/s)$ <i>with gyro OFF</i></p>
Heading Rate TAU	<p>Adjust the responsiveness to the rate of heading change.</p> <p>If the machine is large and unable to turn quickly, increase this value.</p> <p>Default value: 2.0s with gyro enabled Range: 0.0 to 60s Formula: $hrtau (s) = 10 / \text{max rate of the rate of turn } (^\circ/s^2)$</p>

Continued on next page

Configuring the VS1000 Using the WebUI (Bluetooth/Wi-Fi) Continued

Heading menu,
continued,
continued,
continued

Table 3-3: Heading Configurations (continued)

Heading Configuration	Description
COG TAU	<p>The direction the machine is moving.</p> <p>Adjust the responsiveness to the course over ground measurement.</p> <p>If the machine is small and dynamic, leave this value at 0.0 s to be conservative.</p> <p>If the machine is large and resistant to motion, increase this value.</p> <p>Default value: 0.0s Range: 0.0 to 60s Formula: cogtau (s) = 10 / max rate of change of course (°/sec)</p>
Speed TAU	<p>Speed of machine in km/h.</p> <p>Adjust the responsiveness to speed.</p> <p>If the machine is small and dynamic, leave this value at 0.0 s to be conservative.</p> <p>If the machine is large and resistant to motion, increase this value.</p> <p>Default value: 0.0s Range: 0.0 to 60s Formula: spdtau (s) = 10 / max acceleration (m/s²)</p>
MSEP	<p>The measured distance between the primary and secondary antenna. Must be accurate to within 2cm.</p>

Continued on next page

Configuring the VS1000 Using the WebUI (Bluetooth/Wi-Fi), Continued

Heading menu,
continued,
continued,
continued,
continued

Table 3-3: Heading Configurations (continued)

Heading Configuration	Description
CSEP	<p>This is the antenna separation calculated by the receiver. Ensure the CSEP value is within 0.02 of the MSEP value.</p> <p>Note: If CSEP value is “0” the receiver is unable to calculate the separation between the primary and secondary antennas, and you will not receive a valid heading.</p>

Note: Default settings can be changed to set the time constants to smooth heading, Course-over-Ground (COG), and speed measurements.

CAN
Configuration
menu

On the **CAN Configuration** menu, turn ON/OFF CAN and select the baud rate (250 kbps, 500 kbps, or 1000 kbps).

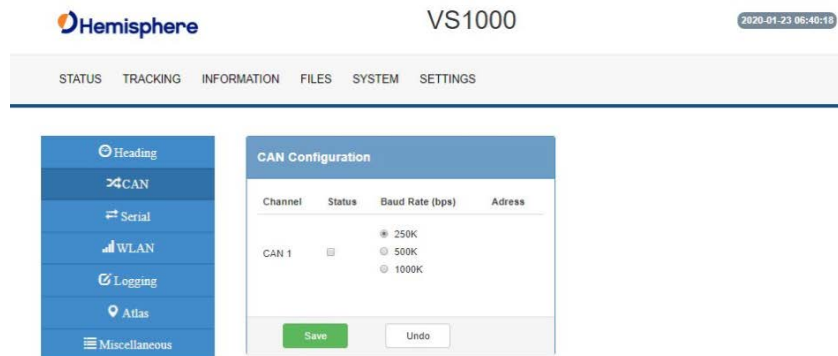

Continued on next page

Configuring the VS1000 Using the WebUI (Bluetooth/Wi-Fi), Continued

Serial tab

Use the **Serial** tab to configure the baud rate of each Serial Port (Port A and Port B) and turn off/on specific NMEA 0183 messages and proprietary Hemisphere BIN messages.

Configure the Serial Port and click **Output**.

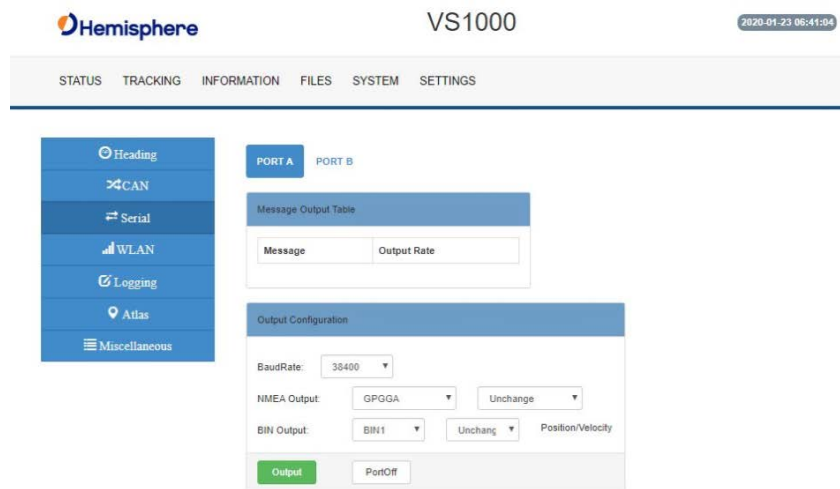

The screenshot shows the Hemisphere VS1000 WebUI interface. The top navigation bar includes STATUS, TRACKING, INFORMATION, FILES, SYSTEM, and SETTINGS. The left sidebar contains menu items: Heading, CAN, Serial (selected), WLAN, Logging, Atlas, and Miscellaneous. The main content area is titled 'PORT A' and 'PORT B'. It features a 'Message Output Table' with columns for 'Message' and 'Output Rate'. Below this is the 'Output Configuration' section for Port A, which includes a 'BaudRate' dropdown set to 38400, an 'NMEA Output' dropdown set to GPWGA with an 'Unchange' button, and a 'BIN Output' dropdown set to BIN1 with an 'Unchang' button and a 'Position/Velocity' label. At the bottom of the configuration section are 'Output' and 'PortOff' buttons.

You can also change Port B from RS-232 to RS-422 and RS-422 to RS-232 reciprocally.

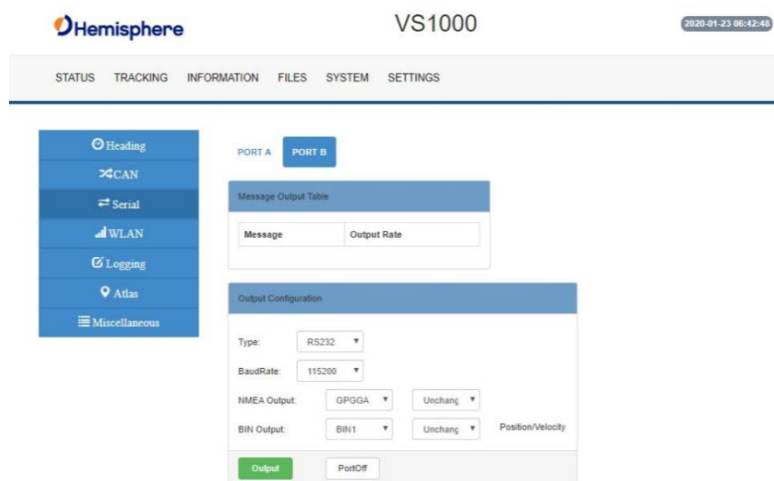

The screenshot shows the Hemisphere VS1000 WebUI interface for Port B configuration. The top navigation bar and left sidebar are identical to the previous screenshot. The main content area is titled 'PORT A' and 'PORT B'. The 'Output Configuration' section for Port B includes a 'Type' dropdown set to RS232, a 'BaudRate' dropdown set to 115200, an 'NMEA Output' dropdown set to GPWGA with an 'Unchang' button, and a 'BIN Output' dropdown set to BIN1 with an 'Unchang' button and a 'Position/Velocity' label. At the bottom of the configuration section are 'Output' and 'PortOff' buttons.

Continued on next page

Configuring the VS1000 Using the WebUI (Bluetooth/Wi-Fi), Continued

WLAN menu Use the **WLAN** menu to configure the WiFi and Bluetooth connections.

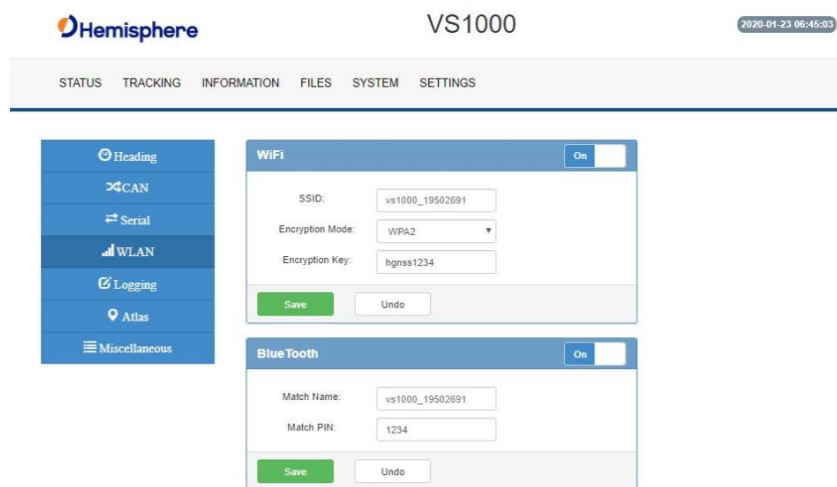

The screenshot displays the Hemisphere VS1000 WebUI interface. At the top, the Hemisphere logo and 'VS1000' are visible, along with a timestamp '2020-01-23 06:45:03'. A navigation bar contains 'STATUS', 'TRACKING', 'INFORMATION', 'FILES', 'SYSTEM', and 'SETTINGS'. A left-hand menu lists 'Heading', 'CAN', 'Serial', 'WLAN', 'Logging', 'Atlas', and 'Miscellaneous'. The 'WLAN' menu item is highlighted. The main content area shows two configuration panels: 'WiFi' and 'BlueTooth'. The 'WiFi' panel has an 'On' toggle, an 'SSID' field with 'vs1000_19502691', an 'Encryption Mode' dropdown set to 'WPA2', and an 'Encryption Key' field with 'hgns1234'. The 'BlueTooth' panel has an 'On' toggle, a 'Match Name' field with 'vs1000_19502691', and a 'Match PIN' field with '1234'. Both panels include 'Save' and 'Undo' buttons.

Continued on next page

Configuring the VS1000 Using the WebUI (Bluetooth/Wi-Fi), Continued

Logging menu Use the **Logging** menu to log data to the internal memory of the VS1000 or download a previously saved log.

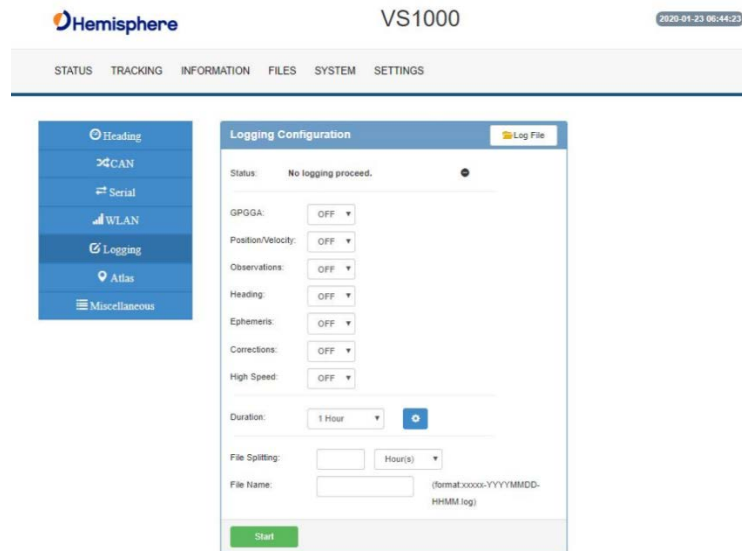

The screenshot displays the Hemisphere VS1000 web interface. At the top, the Hemisphere logo is on the left, 'VS1000' is in the center, and the date '2020-01-23 06:44:23' is on the right. Below this is a navigation bar with 'STATUS', 'TRACKING', 'INFORMATION', 'FILES', 'SYSTEM', and 'SETTINGS'. The 'Logging' menu item is highlighted in the left sidebar. The main content area shows the 'Logging Configuration' window. The status is 'No logging proceed.' with a stop icon. The configuration options are: GPQGA: OFF, Position/Velocity: OFF, Observations: OFF, Heading: OFF, Ephemeris: OFF, Corrections: OFF, High Speed: OFF. The Duration is set to 1 Hour. The File Spitting is set to Hour(s). The File Name field is empty, with a format example '(format:xxxx-YYYYMMDD-HHMM.log)'. A green 'Start' button is at the bottom.

Continued on next page

Configuring the VS1000 Using the WebUI (Bluetooth/Wi-Fi), Continued

Logging menu,
continued

Table 3-4: Logging configuration

Field	Description
GPGGA	Turn on GGA message logging at 0.2Hz, 1Hz, 10Hz, or 20HZ. Note: 10Hz and 20Hz are only available with activations (some kits may come with 10Hz or 20Hz included).
Position/Velocity	Log the position and velocity of the receiver at 0.2Hz, 1Hz, 10Hz, or 20HZ. Note: 10Hz and 20Hz are only available with activations (some kits may come with 10Hz or 20Hz included).
Observations* <small>*This feature is only available if you have a "Raw" activation on the receiver.</small>	Log raw GNSS observations at 0.2Hz, 1Hz, 10Hz, or 20HZ. Note: 10Hz and 20Hz are only available with activations (some kits may come with 10Hz or 20Hz included).
Heading	Heading logs the following messages: <ul style="list-style-type: none"> • GPHDT • GPHDM • GPHDG • HPR • BIN3

Continued on next page

Configuring the VS1000 Using the WebUI (Bluetooth/Wi-Fi), Continued

Logging menu,
continued

Table 3-4: Logging configuration (continued)

Field	Description
Ephemeris* *This feature is only available if you have a "Raw" activation on the receiver.	Log raw GNSS ephemeris messages at 0.2Hz, 1Hz, 10Hz, or 20HZ. Note: 10Hz and 20Hz are only available with activations (some kits may come with 10Hz or 20Hz included).
Corrections	Log the correction messages coming into the receiver.
High Speed	High Speed logs diagnostic data. Note: Selecting that dropdown option forces the GGA, "corrections" and "ephemeris" options on.
Duration	Set the period for which you wish to record data.
File Splitting	Automatically closes a file and restarts a new file after a period of time. Use file splitting to decrease file sizes or to prevent the loss of a file resulting in the loss of all data.
Filename	Choose a filename. All filenames automatically have an appended date and timestamp.

To stop logging, de-select the **Enabled** button and press **Save Settings**.

⚠ WARNING:
If you power off the receiver without properly closing a log, the log file will become corrupted.

Continued on next page

Configuring the VS1000 Using the WebUI (Bluetooth/Wi-Fi), Continued

Atlas menu

In the **Atlas** menu you can manually configure the frequency and bandwidth of the L-band satellite you wish to track, or simply click the **Auto** button and let the receiver track automatically.

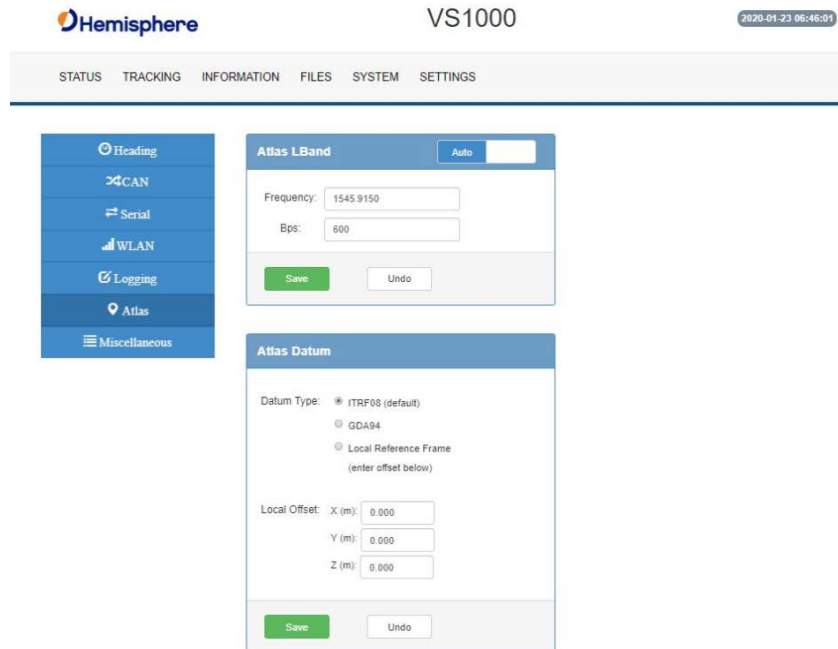

The screenshot displays the Hemisphere VS1000 web interface. At the top, the Hemisphere logo is on the left, 'VS1000' is in the center, and a timestamp '2020-01-23 06:46:01' is on the right. Below this is a navigation bar with tabs: STATUS, TRACKING, INFORMATION, FILES, SYSTEM, and SETTINGS. On the left side, there is a vertical menu with options: Heading, CAN, Serial, WLAN, Logging, Atlas (highlighted), and Miscellaneous. The main content area shows two configuration panels. The 'Atlas LBand' panel has an 'Auto' button, a 'Frequency' input field with the value '1545.9150', a 'Bps' input field with the value '600', and 'Save' and 'Undo' buttons. The 'Atlas Datum' panel has a 'Datum Type' section with radio buttons for 'ITRF08 (default)', 'GDA94', and 'Local Reference Frame (enter offset below)'. Below this is a 'Local Offset' section with input fields for 'X (m): 0.000', 'Y (m): 0.000', and 'Z (m): 0.000', and 'Save' and 'Undo' buttons.

Continued on next page

Configuring the VS1000 Using the WebUI (Bluetooth/Wi-Fi), Continued

Atlas menu,
continued

If using Atlas (**not RTK**), datum defaults to ITRF08.

You can change **Datum Type** to GDA94 or enter custom reference frame offsets.

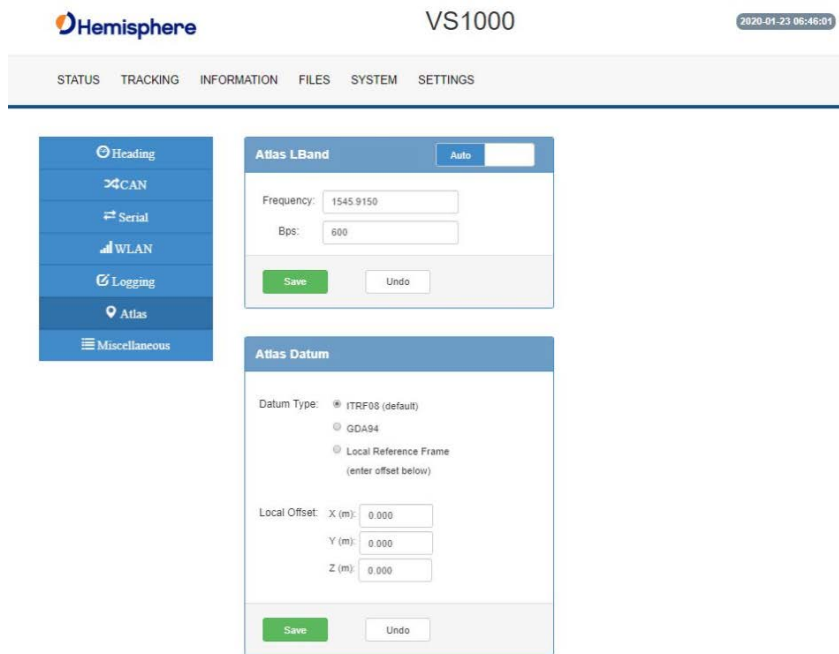

The screenshot shows the Hemisphere VS1000 web interface. At the top, there is a navigation bar with the Hemisphere logo, the device name "VS1000", and a timestamp "2020-01-23 06:46:01". Below the navigation bar are tabs for STATUS, TRACKING, INFORMATION, FILES, SYSTEM, and SETTINGS. A sidebar on the left contains menu items: Heading, CAN, Serial, WLAN, Logging, Atlas (highlighted), and Miscellaneous. The main content area is divided into two panels. The top panel, titled "Atlas LBand", has an "Auto" dropdown and input fields for "Frequency" (1545.9150) and "Bps" (900), with "Save" and "Undo" buttons. The bottom panel, titled "Atlas Datum", has a "Datum Type" section with radio buttons for "ITRF08 (default)", "GDA94", and "Local Reference Frame (enter offset below)". Below this are input fields for "Local Offset: X (m)", "Y (m)", and "Z (m)", all set to "0.000", with "Save" and "Undo" buttons.

Continued on next page

Configuring the VS1000 Using the WebUI (Bluetooth/Wi-Fi), Continued

Miscellaneous menu In the **Miscellaneous** menu, you can change Orientation, Receiver Working Mode, Device Name, and Signal Switch.

Orientation-selects the position in which the receiver is installed.

Receiver Working Mode-selects between Rover, BaseLink and SmartLink.

Device Name-the name of device that displays at the top of the screen.

Signal Switch-switches between Event Mark and 1PPS on pin 1 of the 12-pin connector. This does not impact 1PPS output on the back panel 1PPS BNC connector.

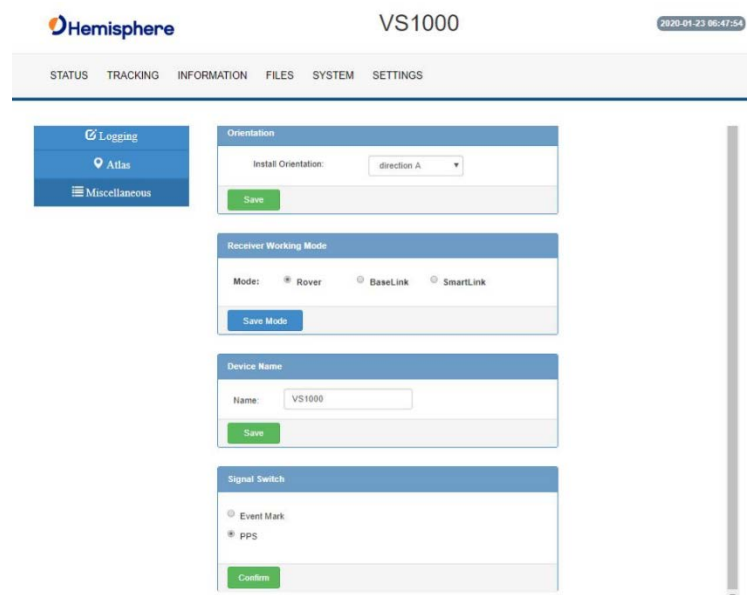

The screenshot shows the Hemisphere VS1000 WebUI interface. At the top, there is a navigation bar with the Hemisphere logo, the device name 'VS1000', and a timestamp '2020-01-23 06:47:54'. Below the navigation bar, there are tabs for 'STATUS', 'TRACKING', 'INFORMATION', 'FILES', 'SYSTEM', and 'SETTINGS'. The 'Miscellaneous' menu is selected, showing a sidebar with 'Logging', 'Atlas', and 'Miscellaneous' options. The main content area displays four configuration sections: 'Orientation' with a dropdown menu set to 'direction A' and a 'Save' button; 'Receiver Working Mode' with radio buttons for 'Rover' (selected), 'BaseLink', and 'SmartLink', and a 'Save Mode' button; 'Device Name' with a text input field containing 'VS1000' and a 'Save' button; and 'Signal Switch' with radio buttons for 'Event Mark' and 'PPS' (selected), and a 'Confirm' button.

Configuring the VS1000 Using the WebUI (Ethernet)

Overview

The VS1000 is equipped with an onboard WebUI you can access by using an Ethernet connection.

To access this Ethernet WebUI, please use the following instructions:

To set up the Ethernet you will need to update the GNSS firmware to 6.0Aa00 or later.

- 1) Connect the VS1000 to a network switch, and send the following commands over a serial port:
 - a. \$JETHERNET,MODE,DHCP
 - b. \$JETHERNET,PORTI,xxxx (Where xxxx equals a four-digit number)
 - c. \$JETHERNET,WEBUI,ON
 - d. \$JSAVE

Re-send the \$JETHERNET command over the serial port. The response will have a dynamic IP address that you can use to connect to the Ethernet port as well as the Ethernet based WebUI.

Note: The VS1000 WebUI supports Chrome and Firefox web browsers.

Continued on next page

Configuring the VS1000 Using the WebUI (Ethernet), Continued

Status tab

The VS1000 **Status** tab displays Receiver, Position, Heading, Precision, Solution Status, and L-band/SBAS information.

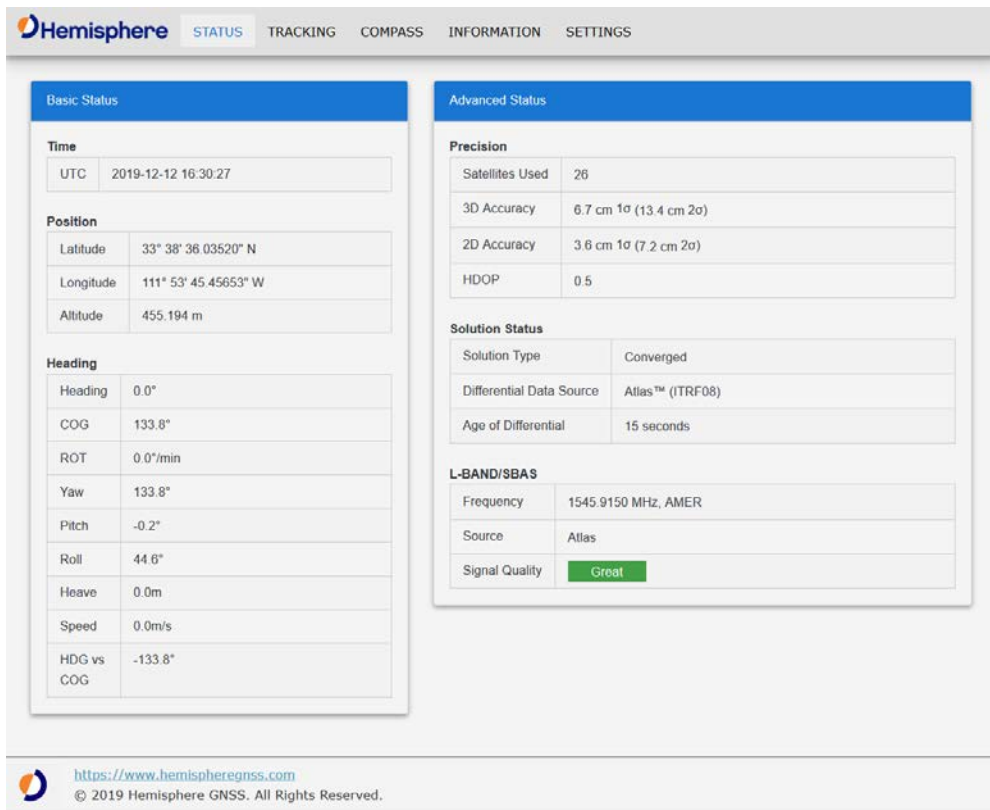

The screenshot shows the Hemisphere VS1000 WebUI interface with the 'STATUS' tab selected. The interface is divided into two main sections: 'Basic Status' and 'Advanced Status'.

Basic Status

Time	
UTC	2019-12-12 16:30:27

Position	
Latitude	33° 38' 36.03520" N
Longitude	111° 53' 45.45653" W
Altitude	455.194 m

Heading	
Heading	0.0°
COG	133.8°
ROT	0.0°/min
Yaw	133.8°
Pitch	-0.2°
Roll	44.6°
Heave	0.0m
Speed	0.0m/s
HDG vs COG	-133.8°

Advanced Status

Precision	
Satellites Used	26
3D Accuracy	6.7 cm 1 σ (13.4 cm 2 σ)
2D Accuracy	3.6 cm 1 σ (7.2 cm 2 σ)
HDOP	0.5

Solution Status	
Solution Type	Converged
Differential Data Source	Atlas™ (ITRF08)
Age of Differential	15 seconds

L-BAND/SBAS	
Frequency	1545.9150 MHz, AMER
Source	Atlas
Signal Quality	Great

Footer: <https://www.hemispheregnss.com>
© 2019 Hemisphere GNSS. All Rights Reserved.

Continued on next page

Configuring the VS1000 Using the WebUI (Ethernet), Continued

Status tab,
continued

Table 3-5: Status fields

Field	Description
Time	UTC time obtained from satellites; Local time configured in Settings; Miscellaneous tab
Position	Latitude, Longitude, Altitude
Heading	Heading, COG, ROT, YAW, pitch, roll, heave, speed, and the difference between heading and COG
Precision	Satellites used in solution, 3D Accuracy, 2D Accuracy, horizontal dilution of precision
Solution Status	Solution type, correction source, correction signal latency
L-band /SBAS	Atlas Frequency, Source, Bit Error Rate, Carrier Lock, DSP Lock, Frame Sync, Frame Sync 2*

***Note:** For a definition of the L-band/SBAS fields refer to [VS1000 Terms and Definitions](#) in this document.

Tracking tab

On the **Tracking** tab, the Sky Plot shows the azimuth, elevation, and SNR values of all tracked satellites.

Continued on next page

Configuring the VS1000 Using the WebUI (Ethernet), Continued

Serial menu

Use the Serial menu to configure the baud rate of each Serial Port (Port A and Port B) and turn off/on specific NMEA 0183 messages and proprietary Hemisphere BIN messages.

Configure the Serial Port and click **Output**.

You can also change Port B from RS-232 to RS-422 and RS-422 to RS-232 reciprocally.

Continued on next page

Configuring the VS1000 Using the WebUI (Ethernet), Continued

Compass tab The **Compass** tab contains a compass graphic and displays the Heading and COG readings.

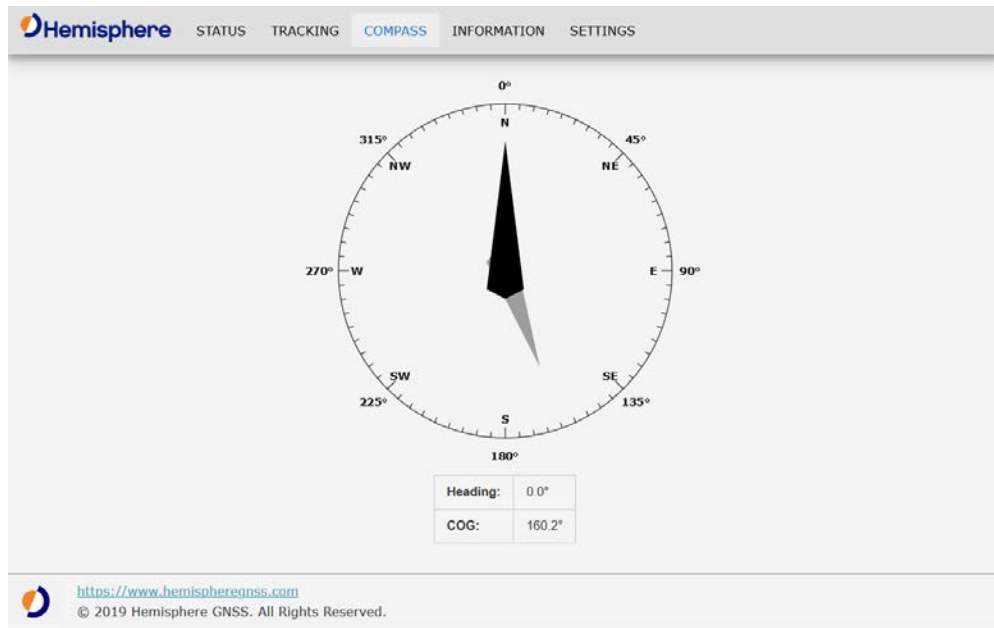

Continued on next page

Configuring the VS1000 Using the WebUI (Ethernet), Continued

Compass tab,
continued

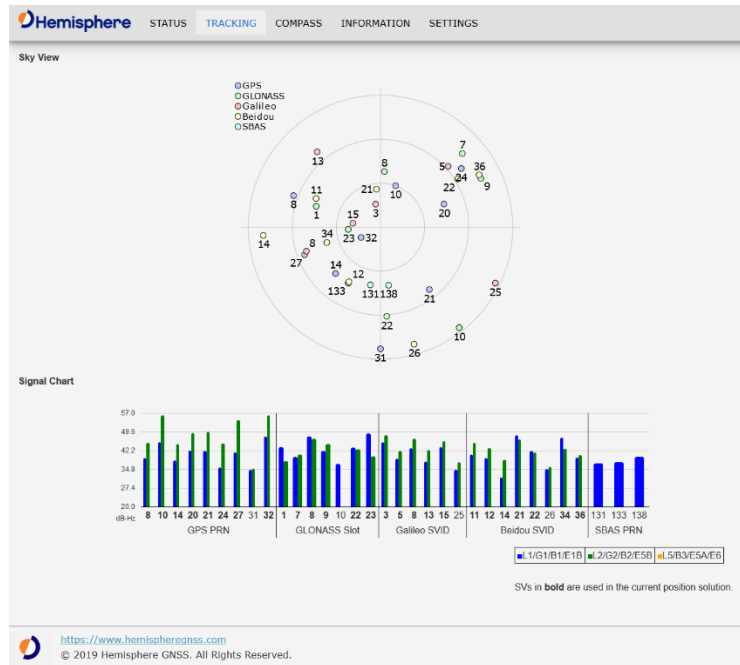

Continued on next page

Configuring the VS1000 Using the WebUI (Ethernet), Continued

Information tab On the **Information** tab, you can see the ESN, Board Type, and GNSS Firmware.

Important: If you have purchased an activation or subscription, go to the **Settings** menu item, click **Systems**, enter the code and click **Update**.

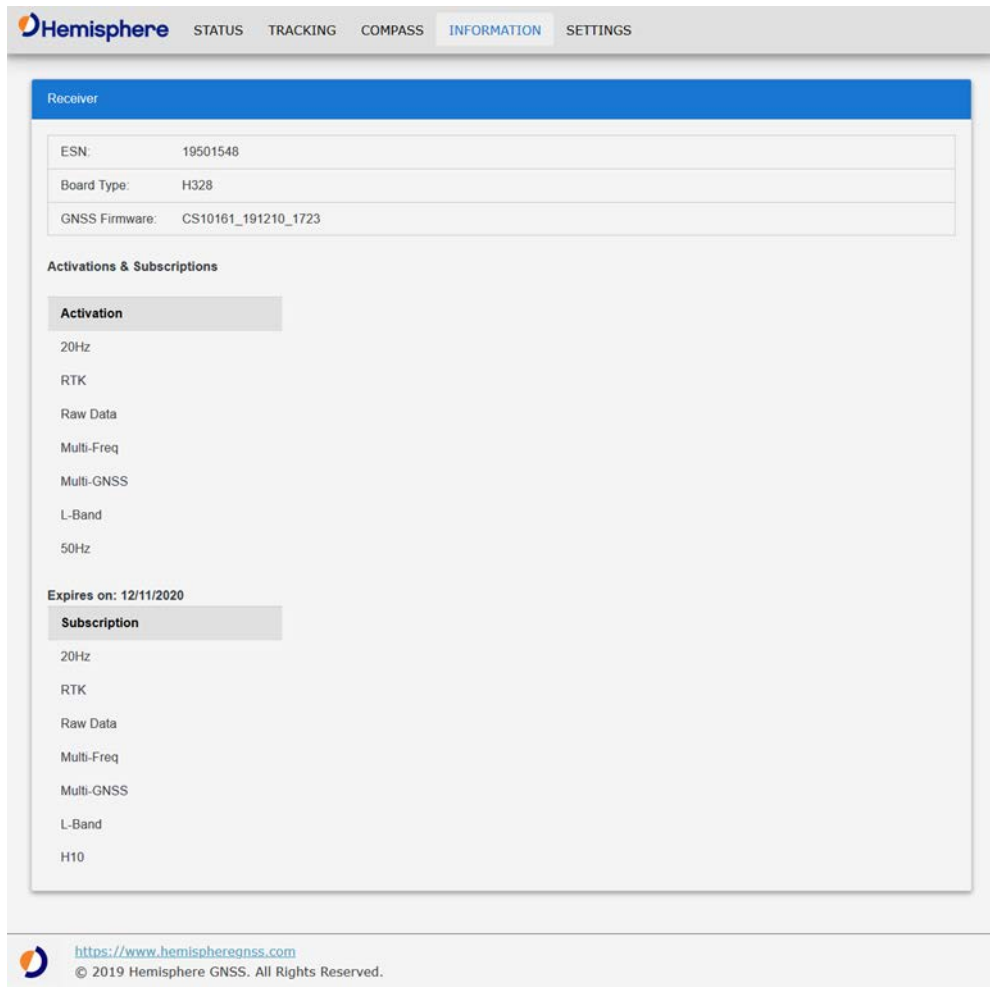

The screenshot shows the Hemisphere web interface with the 'INFORMATION' tab selected. The 'Receiver' section displays the following details:

ESN:	19501548
Board Type:	H328
GNSS Firmware:	CS10161_191210_1723

Below this, the 'Activations & Subscriptions' section is visible. It includes two sub-sections: 'Activation' and 'Subscription'. Each sub-section lists various options: 20Hz, RTK, Raw Data, Multi-Freq, Multi-GNSS, L-Band, and 50Hz. The 'Expires on: 12/11/2020' date is also shown. At the bottom of the interface, there is a footer with the URL <https://www.hemispheregnss.com> and the copyright notice '© 2019 Hemisphere GNSS. All Rights Reserved.'

Continued on next page

Configuring the VS1000 Using the WebUI (Ethernet), Continued

Information tab On the **Settings** tab, you can configure the following menus using the VS1000 WebUI:

tab

- Ethernet
- Heading
- Serial
- NTRIP
- USB
- Atlas
- System

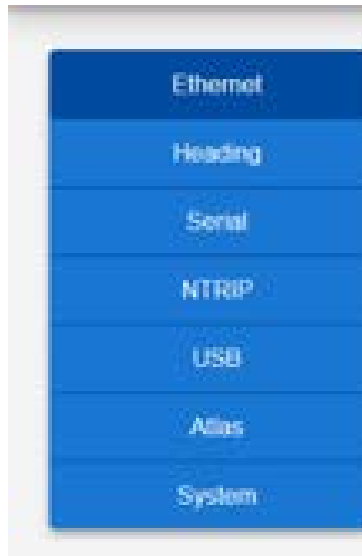

Continued on next page

Configuring the VS1000 Using the WebUI (Ethernet), Continued

Ethernet menu Use the **Ethernet** menu to configure the Ethernet connection.

To enable Ethernet, first decide if you wish to allow the receiver to be assigned an IP address automatically via DHCP, or statically assigned. If you are unsure, please contact the administrator of the network you wish to connect it to.

Select either **DHCP** or **Static**. If selecting **Static**, type the appropriate credentials.

To test if the Ethernet is enabled, send an ICMP ping to the receiver from a PC on the same network. Note no actual services are enabled on Ethernet by default, so to make practical use of Ethernet support, you must also enable a service.

As of the version 6.0.0 firmware, the only services implemented include the Port I virtual serial port, Port UDP, and NTRIP CLIENT. Additional types of network services may be implemented in future firmware versions.

For example, it is possible to enable the Port I virtual serial port as a TCP server. Once a connection to it is made, it will act just like a local serial port of the receiver. Only one TCP client may be connected to it at a time.

Important Note: Enabling Port I as a TCP server should only be done when the network the receiver is connected to a trusted network, since it gives full access to the receiver with no authentication mechanism.

To enable Port I service, use the drop-down menu to turn the Port I and assign the Port an IP address between 1 and 65535.

Continued on next page

Configuring the VS1000 Using the WebUI (Ethernet), Continued

Ethernet menu,
continued

As an additional note, when the connected to a network, the receiver can be accessed with a hostname of “hgns#####.local” where ##### is replaced with the receiver’s electronic serial number as is reported by the \$JI command. This can make it easier to connect to a receiver on a local network assigned an IP address by DHCP, so there is no need to check which IP address was assigned.

The VS1000 allows configuring a virtual serial port for transmitting messages via UDP packets. Up to four destination host/port pairs may be specified, and messages will be sent to all simultaneously. This is for outgoing data only, and incoming data or commands via UDP are not accepted.

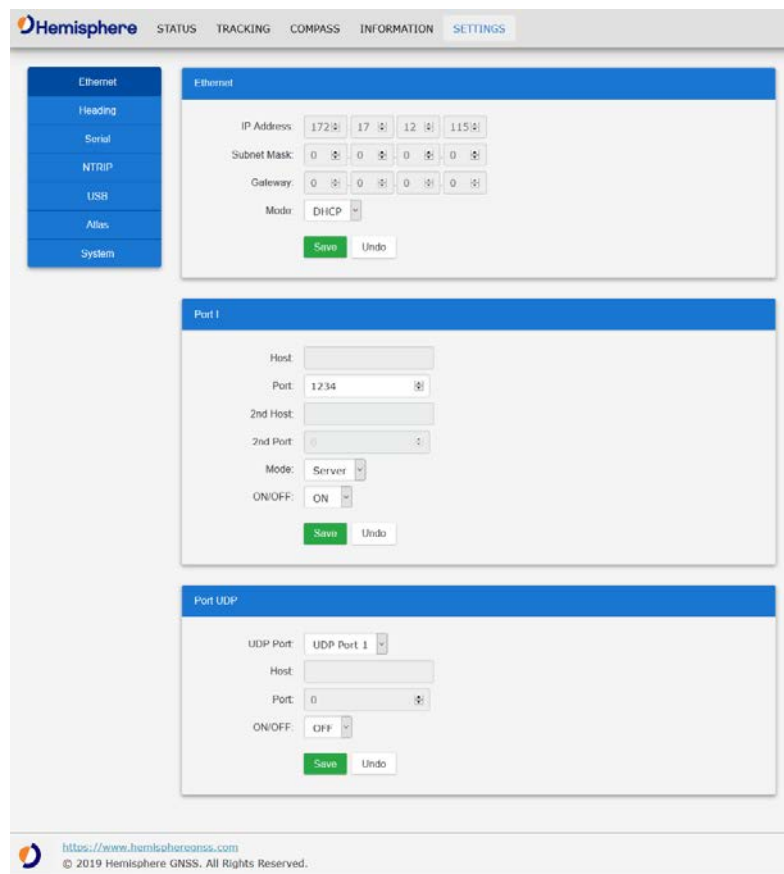

Continued on next page

Configuring the VS1000 Using the WebUI (Ethernet), Continued

Heading menu The **Heading** menu displays the configuration data. Various heading settings can also be configured.

Click the box of the desired setting and type the configuration setting values.

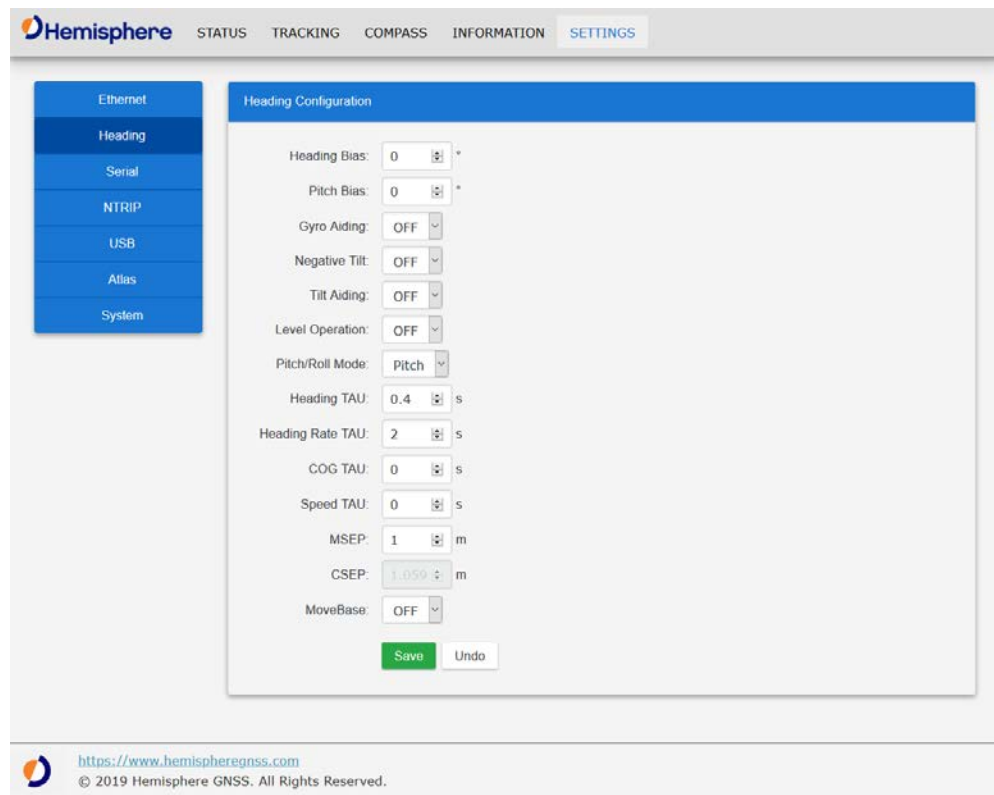

The screenshot shows the Hemisphere webUI interface. At the top, there are navigation tabs: STATUS, TRACKING, COMPASS, INFORMATION, and SETTINGS. The SETTINGS tab is active. On the left, there is a vertical menu with options: Ethernet, Heading, Serial, NTRIP, USB, Alias, and System. The main content area is titled "Heading Configuration" and contains the following settings:

- Heading Bias: 0
- Pitch Bias: 0
- Gyro Aiding: OFF
- Negative Tilt: OFF
- Tilt Aiding: OFF
- Level Operation: OFF
- Pitch/Roll Mode: Pitch
- Heading TAU: 0.4 s
- Heading Rate TAU: 2 s
- COG TAU: 0 s
- Speed TAU: 0 s
- MSEP: 1 m
- CSEP: 1.050 m
- MoveBase: OFF

At the bottom of the configuration area, there are "Save" and "Undo" buttons. At the bottom of the page, there is a footer with the URL <https://www.hemispheregnss.com> and the copyright notice "© 2019 Hemisphere GNSS. All Rights Reserved."

Continued on next page

Configuring the VS1000 Using the WebUI (Ethernet), Continued

Heading menu, continued **Table 3-6: Heading Configurations**

Heading Configuration	Description
Heading Bias	<p>Add a bias to the heading value the receiver outputs.</p> <p>Heading is defined as the direction of the vector created from the primary to secondary antenna. Heading is measured using true north.</p> <p>Range: -180 – +180</p>
Pitch Bias	<p>Add a bias to the pitch value the receiver outputs.</p> <p>If the receiver is in “roll” mode, this will add a bias to the roll instead.</p> <p>Range: -15 – +15</p>
Gyro Aiding	<p>Gyro aiding enables the use of the internal gyro sensor and allows for the continuous output of heading for up to three minutes during a GNSS outage. Gyro aiding improves the reacquisition time when GNSS heading is lost because of an obstruction in GNSS signal.</p>
Negative Tilt	<p>Change the sign of the pitch/roll measurement.</p>
Tilt Aiding	<p>Turn OFF or ON tilt aiding. When on, the sensors are used to reduce the RTK search volume – improving heading start up and reacquisition times.</p>
Level Operation	<p>If the Vector will be operated within +/- 10 degrees of level, you may use this mode of operation for increased robustness and faster acquisition times of the heading solution.</p>

Continued on next page

Configuring the VS1000 Using the WebUI (Ethernet), Continued

Heading menu,
continued,
continued

Table 3-6: Heading Configurations (continued)

Heading Configuration	Description
Pitch/Roll Mode	<p>If the antennas are mounted such that they model pitch, set to PITCH.</p> <p>If the antennas are mounted such that they model roll, set to ROLL.</p> <p>Note: If your HBIAS is -90 or +90, set this to ROLL. If your HBIAS is 0 or 180, set this to PITCH.</p>
Heading TAU	<p>Adjust the responsiveness to true heading.</p> <p>If the machine is large and unable to turn quickly, increase this value.</p> <p>For longer baselines (10 m) HTAU should be between 0.1 and 0.5, since the gyro introduces noise.</p> <p>Default value: 0.1s with gyro enabled Range: 0.0 to 60s Formula: $htau (s) = 40 / \text{max rate of turn } (^\circ/s)$ <i>with gyro ON</i> $htau (s) = 10 / \text{max rate of turn } (^\circ/s)$ <i>with gyro OFF</i></p>
Heading Rate TAU	<p>Adjust the responsiveness to the rate of heading change.</p> <p>If the machine is large and unable to turn quickly, increase this value.</p> <p>Default value: 2.0s with gyro enabled Range: 0.0 to 60s Formula: $hrtau (s) = 10 / \text{max rate of the rate of turn } (^\circ/s^2)$</p>

Continued on next page

Configuring the VS1000 Using the WebUI (Ethernet), Continued

Heading menu,
continued,
continued,
continued

Table 3-6: Heading Configurations (continued)

Heading Configuration	Description
COG TAU	<p>The direction the machine is moving.</p> <p>Adjust the responsiveness to the course over ground measurement.</p> <p>If the machine is small and dynamic, leave this value at 0.0s to be conservative.</p> <p>If the machine is large and resistant to motion, increase this value.</p> <p>Default value: 0.0s Range: 0.0 to 60s Formula: cogtau (s) = 10 / max rate of change of course (°/sec)</p>
Speed TAU	<p>Speed of machine in km/h. Adjust the responsiveness to speed.</p> <p>If the machine is small and dynamic, leave this value at 0.0 s to be conservative.</p> <p>If the machine is large and resistant to motion, increase this value.</p> <p>Default value: 0.0s Range: 0.0 to 60s Formula: spdtau (s) = 10 / max acceleration (m/s²)</p>
MSEP	<p>The measured distance between the primary and secondary antenna. Must be accurate to within 2cm.</p>

Continued on next page

Configuring the VS1000 Using the WebUI (Ethernet), Continued

Heading menu,
continued,
continued,
continued,
continued

Table 3-6: Heading Configurations (continued)

Heading Configuration	Description
CSEP	<p>This is the antenna separation calculated by the receiver. Ensure the CSEP value is within 0.02 of the MSEP value.</p> <p>Note: If CSEP value is “0” the receiver is unable to calculate the separation between the primary and secondary antennas, and you will not receive a valid heading.</p>
MoveBase	<p>If the receiver is capable of multi-frequency operation, you can turn the setting on to allow the receiver to calculate the heading with no MSEP value. If the receiver is not capable of multi-frequency operation, you must turn MoveBase off.</p>

Note: Default settings can be changed to set the time constants to smooth heading, Course-over-Ground (COG), and speed measurements.

Continued on next page

Configuring the VS1000 Using the WebUI (Ethernet), Continued

Serial menu

Use the **Serial** menu to configure the baud rate of each serial port (Port A and Port B) and turn off/on specific NMEA 0183 messages and proprietary Hemisphere messages. You can also configure the message output of Port I and Port UDP.

You can also switch Port B between RS-232 to RS-422.

Configure the Serial Port and click **Output**.

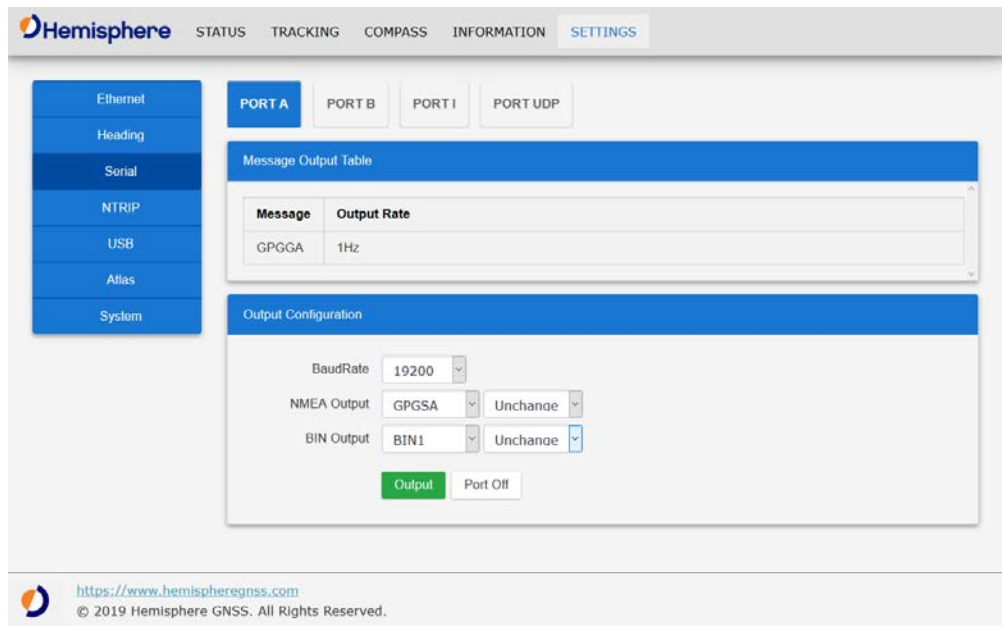

The screenshot shows the Hemisphere web interface with the 'SETTINGS' tab selected. On the left, a navigation menu includes 'Ethernet', 'Heading', 'Serial', 'NTRIP', 'USB', 'Atlas', and 'System'. The 'Serial' menu is active, and 'PORT A' is selected. The 'Message Output Table' displays a table with the following content:

Message	Output Rate
GPGGA	1Hz

The 'Output Configuration' section includes the following settings:

- BaudRate: 19200
- NMEA Output: GPGSA (Unchange)
- BIN Output: BIN1 (Unchange)

Buttons for 'Output' and 'Port Off' are visible at the bottom of the configuration area. The footer contains the URL <https://www.hemispheregnss.com> and the copyright notice '© 2019 Hemisphere GNSS. All Rights Reserved.'

Continued on next page

Configuring the VS1000 Using the WebUI (Ethernet), Continued

NTRIP menu The **NTRIP** menu shows the Status, RX Count, Time, Host, Port, Mount Point, Username, and Password. Click **Connect**.

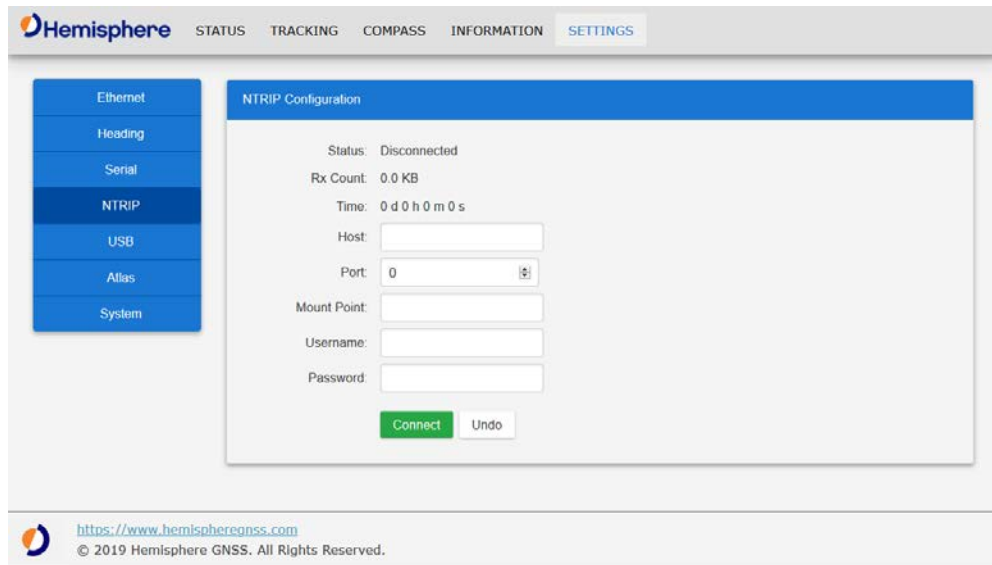

The screenshot shows the Hemisphere web interface with the 'SETTINGS' tab selected. On the left, a navigation menu lists 'Ethernet', 'Heading', 'Serial', 'NTRIP', 'USB', 'Atlas', and 'System'. The 'NTRIP' menu item is highlighted. The main content area is titled 'NTRIP Configuration' and displays the following information:

- Status: Disconnected
- Rx Count: 0.0 KB
- Time: 0 d 0 h 0 m 0 s
- Host:
- Port:
- Mount Point:
- Username:
- Password:

At the bottom of the configuration area are two buttons: 'Connect' (green) and 'Undo' (white). The footer contains the URL <https://www.hemispheregnss.com> and the copyright notice '© 2019 Hemisphere GNSS. All Rights Reserved.'

USB menu The **USB** menu allows you to configure the message output of Port U.

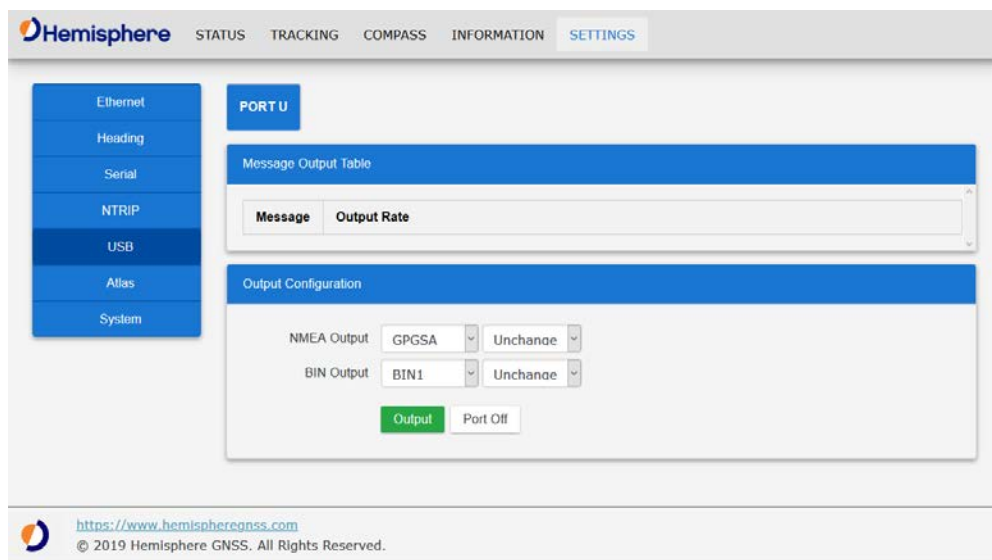

The screenshot shows the Hemisphere web interface with the 'SETTINGS' tab selected. On the left, a navigation menu lists 'Ethernet', 'Heading', 'Serial', 'NTRIP', 'USB', 'Atlas', and 'System'. The 'USB' menu item is highlighted. The main content area is titled 'PORT U' and displays the following information:

- Message Output Table: A table with columns 'Message' and 'Output Rate'.
- Output Configuration:
 - NMEA Output: GPGSA (dropdown), Unchange (dropdown)
 - BIN Output: BIN1 (dropdown), Unchange (dropdown)

At the bottom of the configuration area are two buttons: 'Output' (green) and 'Port Off' (white). The footer contains the URL <https://www.hemispheregnss.com> and the copyright notice '© 2019 Hemisphere GNSS. All Rights Reserved.'

Continued on next page

Configuring the VS1000 Using the WebUI (Ethernet), Continued

Atlas menu

In the **Atlas** menu, you can manually configure the frequency and bandwidth of the L-band satellite you wish to track, or simply click the **Auto** button and let the receiver track automatically.

Atlas Datum

Datum Type: By default, the reference frame that Atlas uses is ITRF08. Use the drop-down box to select from GDA94 or to add Reference Frame (custom offsets) to ITRF08.

If you select the option to use Reference Frame, you can either add an XYZ Cartesian coordinate offset (in meters) or a Geodetic NEZ offset (in meters, feet, or degrees).

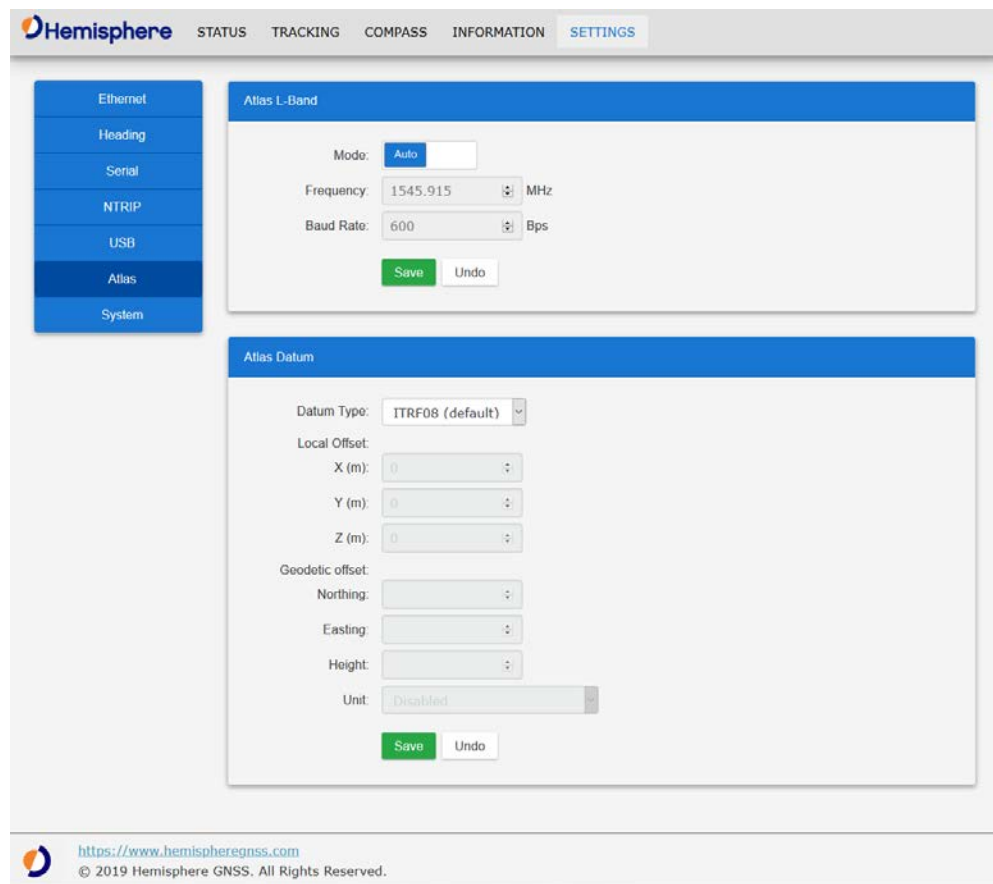

The screenshot displays the Hemisphere webUI interface, specifically the Settings page. The top navigation bar includes 'STATUS', 'TRACKING', 'COMPASS', 'INFORMATION', and 'SETTINGS'. A left sidebar lists menu items: Ethernet, Heading, Serial, NTRIP, USB, Atlas (highlighted), and System. The main content area is divided into two sections: 'Atlas L-Band' and 'Atlas Datum'. The 'Atlas L-Band' section features a 'Mode' dropdown set to 'Auto', a 'Frequency' input field with '1545.915' and a unit dropdown set to 'MHz', and a 'Baud Rate' input field with '600' and a unit dropdown set to 'Bps'. Below these are 'Save' and 'Undo' buttons. The 'Atlas Datum' section has a 'Datum Type' dropdown set to 'ITRF08 (default)'. Under 'Local Offset', there are three input fields for 'X (m)', 'Y (m)', and 'Z (m)', each with a unit dropdown. Under 'Geodetic offset', there are three input fields for 'Northing', 'Easting', and 'Height', each with a unit dropdown. A 'Unit' dropdown is set to 'Disabled'. 'Save' and 'Undo' buttons are at the bottom. The footer contains the URL 'https://www.hemispheregnss.com' and the copyright notice '© 2019 Hemisphere GNSS. All Rights Reserved.'

Continued on next page

Configuring the VS1000 Using the WebUI (Ethernet), Continued

System menu The **System** menu displays the current Firmware and Subscription information. To update Firmware, click **Browse**. To update Subscription, enter the new code and click **Update**.

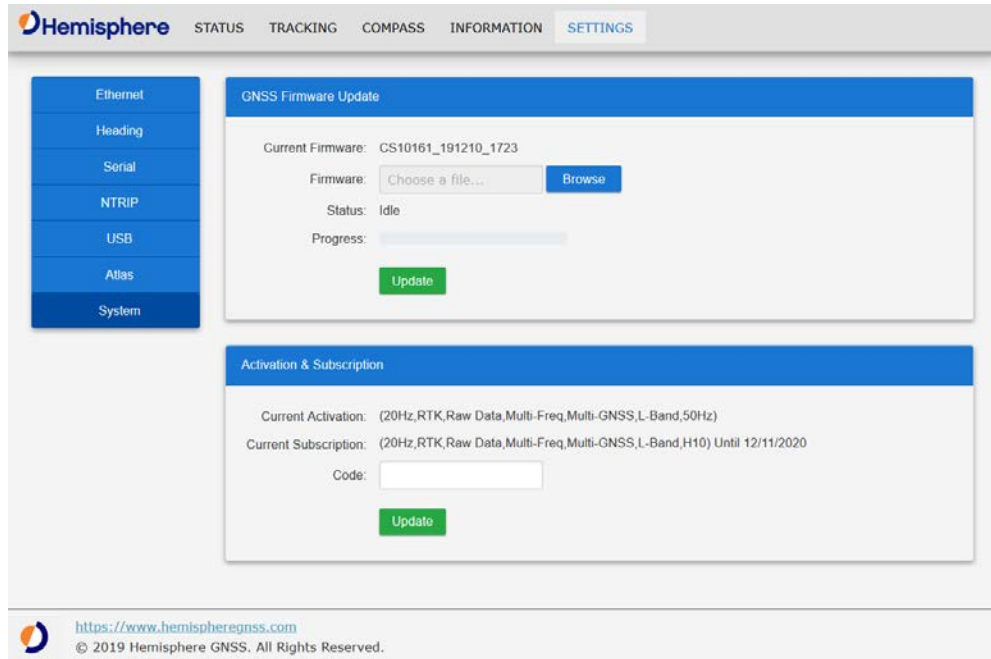

The screenshot displays the Hemisphere web interface. At the top, there is a navigation bar with the Hemisphere logo and tabs for STATUS, TRACKING, COMPASS, INFORMATION, and SETTINGS. A left-hand sidebar contains a menu with options: Ethernet, Heading, Serial, NTRIP, USB, Atlas, and System (which is highlighted). The main content area is divided into two sections. The first section, titled "GNSS Firmware Update", shows the current firmware version as CS10161_191210_1723. It includes a "Firmware:" field with a "Choose a file..." button and a "Browse" button. Below this, the status is "Idle" and there is a progress bar. An "Update" button is located at the bottom of this section. The second section, titled "Activation & Subscription", shows the current activation and subscription details: "(20Hz,RTK,Raw Data,Multi-Freq,Multi-GNSS,L-Band,50Hz)". It also shows the current subscription: "(20Hz,RTK,Raw Data,Multi-Freq,Multi-GNSS,L-Band,H10) Until 12/11/2020". There is a "Code:" input field and an "Update" button at the bottom of this section. At the bottom of the page, there is a footer with the URL <https://www.hemispheregnss.com> and the copyright notice "© 2019 Hemisphere GNSS. All Rights Reserved."

Common Commands and Messages

VS1000 Commands & messages

Table 3-7 below provides a brief description of common NMEA commands and messages for the VS1000.

Table 3-7: NMEA received messages based on a request

PG No. (PGN)	Description	Default Update Rate (msec)	Freq (Hz)
059392	ISO Acknowledgment Used to acknowledge the status of certain requests addressed to a specific ECU.	On Request	On Request
059904	ISO Request Request the transmission of a specific PGN, addressed or broadcast.	On Request	On Request
060928	ISO Address Claim Used to identify to other ECUs the address claimed by an ECU.	On Request	On Request

Continued on next page

Common Commands and Messages, Continued

VS1000
Commands &
messages,
continued

Table 3-4: NMEA received messages based on a request (continued)

PG No. (PGN)	Description	Default Update Rate (msec)	Freq (Hz)
126996	Product Information NMEA 2000 database version supported, manufacturer's product code, NMEA 2000 certification level, Load Equivalency number, and other product-specific information.	On Request	On Request
126208	Request group function The Request / Command / Acknowledge Group type of function is defined by first field. The message will be a Request, Command, or Acknowledge Group Function.	On Request	On Request
126464	Receive/Transmit PGNs group function The Transmit / Receive PGN List Group type of function is defined by the first field. The message will be a Transmit or Receive PGN List group function.	On Request	On Request

Continued on next page

Common Commands and Messages, Continued

VS1000
Commands &
messages,
continued

Table 3-7: NMEA received messages based on a request (continued)

PG No. (PGN)	Description	Default Update Rate (msec)	Freq (Hz)
129538	GNSS Control Status GNSS common satellite receiver parameter status.	On Request	On Request
129545	GNSS RAIM Output Autonomous Integrity Monitoring (RAIM) process. The Integrity field value is based on the parameters set in PGN 129546 GNSS RAIM settings.	On Request	On Request
129546	GNSS RAIM Settings Used to report the control parameters for a GNSS receiver Autonomous Integrity Monitoring (RAIM) process.	On Request	On Request
126992	System Time The purpose of this PGN is twofold: to provide a regular transmission of UTC time, date, and to provide synchronism for measurement data.	1000	0

Continued on next page

Common Commands and Messages, Continued

VS1000
Commands &
messages,
continued

Table 3-7: NMEA received messages based on a request (continued)

PG No. (PGN)	Description	Default Update Rate (msec)	Freq (Hz)
127250	Vessel Heading Heading sensor value with a flag for True or Magnetic. If the sensor value is Magnetic, the deviation field can be used to produce a Magnetic heading, and the variation field can be used to correct the Magnetic heading to produce a True heading.	100	20
127251	Rate of Turn Rate of change of the Heading.	100	10
127257	Attitude Provides a single transmission that describes the position of a vessel relative to both horizontal and vertical planes. This would typically be used for vessel stabilization, vessel control and on-board platform stabilization.	1000	20

Continued on next page

Common Commands and Messages, Continued

VS1000
Commands &
messages,
 continued

Table 3-7: NMEA received messages based on a request (continued)

PG No. (PGN)	Description	Default Update Rate (msec)	Freq (Hz)
127258	Magnetic Variation Message for transmitting variation. The message contains a sequence number to allow synchronization of other messages such as Heading or Course over Ground. The quality of service and age of service are provided to enable recipients to determine an appropriate level of service if multiple transmissions exist.	1000	1

Continued on next page

Common Commands and Messages, Continued

VS1000
Commands &
messages,
continued

Table 3-7: NMEA received messages based on a request (continued)

PG No. (PGN)	Description	Default Update Rate (msec)	Freq (Hz)
129025	<p>Position, Rapid Update</p> <p>Provides latitude and longitude referenced to WGS84. Being defined as single frame message, as opposed to other PGNs that include latitude and longitude and are defined as fast or multi-packet, this PGN lends itself to being transmitted more frequently without using up excessive bandwidth on the bus for the benefit of receiving equipment that may require rapid position updates.</p>	100	0
129026	<p>COG & SOG, Rapid Update</p> <p>Single frame PGN that provides Course Over Ground (COG) and Speed Over Ground (SOG).</p>	250	4

Continued on next page

Common Commands and Messages, Continued

VS1000
Commands &
messages,
continued

Table 3-7: NMEA received messages based on a request (continued)

PG No. (PGN)	Description	Default Update Rate (msec)	Freq (Hz)
129027	<p>Position Delta, High Precision Rapid Update</p> <p>The “Position Delta, High Precision Rapid Update” Parameter Group is intended for applications where very high precision and very fast update rates are needed for position data. This PGN can provide delta position changes down to 1 mm with a delta time period accurate to 5 msec.</p>	100	20

Continued on next page

Common Commands and Messages, Continued

VS1000
Commands &
messages,
continued

Table 3-7: NMEA received messages based on a request (continued)

PG No. (PGN)	Description	Default Update Rate (msec)	Freq (Hz)
129028	<p>Altitude Delta, High Precision Rapid Update</p> <p>The “Altitude Delta, High Precision Rapid Update” Parameter Group is intended for applications where very high precision and very fast update rates are needed for altitude and Course Over Ground data. This PGN can provide delta altitude changes down to 1 millimeter, a change in direction as small as 0.0057°, and with a delta time period accurate to 5 msec.</p>	100	20
129029	<p>GNSS Position Data</p> <p>Conveys a comprehensive set of Global Navigation Satellite System (GNSS) parameters, including position information.</p>	1000	1

Continued on next page

Common Commands and Messages, Continued

VS1000
Commands &
messages,
 continued

Table 3-7: NMEA received messages based on a request (continued)

PG No. (PGN)	Description	Default Update Rate (msec)	Freq (Hz)
129033	Time & Date Single transmission that provides UTC time, UTC Date, and Local Offset.	1000	0
129539	GNSS DOPs Provides a single transmission containing GNSS status and dilution of precision components (DOP) that indicate the contribution of satellite geometry to the overall position error. There are three DOP parameters reported: horizontal (HDOP), vertical (VDOP), and time (TDOP).	1000	1

Continued on next page

Common Commands and Messages, Continued

VS1000
Commands &
messages,
continued

Table 3-7: NMEA received messages based on a request (continued)

PG No. (PGN)	Description	Default Update Rate (msec)	Freq (Hz)
129540	GNSS Sats in View GNSS information on current satellites in view tagged by sequence ID. Information includes PRN, elevation, azimuth, SNR, defines the number of satellites; defines the satellite number and the information.	1000	1
129542	GNSS Pseudo-range Noise Statistics GNSS pseudo-range measurement noise statistics can be translated in the position domain in order to give statistical measures of the quality of the position solution. Intended for use with a receiver Autonomous Integrity Monitoring (RAIM) application.	1000	1
196552	Receiver Diagnostics and Status Information	1000	1

This table contains information found in the NMEA 2000® Standard manual. NMEA 2000 is a registered trademark of the National Marine Electronics Association.

Appendix A: Technical Specifications

Overview

Introduction

Appendix A contains the technical specifications for the Vector VS1000.

Contents

Topic	See Page
VS1000 Technical Specifications	93

VS1000 Technical Specifications

**VS1000
Technical
specifications**

Table A-1: GNSS sensor

Item	Specification															
Receiver type	GPS, GLONASS, BeiDou, Galileo, QZSS, Atlas L-band, RTK															
Signals received	GPS L1CA/L1P/L1C/L2P/L2C/L5 GLONASS G1/G2, P1/P2 BeiDou B1/B2/B3 GALILEO E1BC/E5a/E5b QZSS L1CA/L1C/L2C/L5 Atlas L-band															
Channels	1059															
GNSS sensitivity	-142 dBm															
SBAS tracking	3-channel, parallel tracking															
Update rate	10 Hz standard, up to 20 Hz optional															
Horizontal accuracy	<table border="1"> <thead> <tr> <th></th> <th>RMS (67%)</th> <th>2DRMS (95%)</th> </tr> </thead> <tbody> <tr> <td>RTK^{1,2}</td> <td>10 mm + 1 ppm</td> <td>20 mm + 2 ppm</td> </tr> <tr> <td>Atlas H10 (L-band)¹</td> <td>0.04 m</td> <td>0.08 m</td> </tr> <tr> <td>SBAS (WAAS)¹</td> <td>0.3 m</td> <td>0.6 m</td> </tr> <tr> <td>Autonomous, no SA¹</td> <td>1.2 m</td> <td>2.5 m</td> </tr> </tbody> </table>		RMS (67%)	2DRMS (95%)	RTK ^{1,2}	10 mm + 1 ppm	20 mm + 2 ppm	Atlas H10 (L-band) ¹	0.04 m	0.08 m	SBAS (WAAS) ¹	0.3 m	0.6 m	Autonomous, no SA ¹	1.2 m	2.5 m
		RMS (67%)	2DRMS (95%)													
	RTK ^{1,2}	10 mm + 1 ppm	20 mm + 2 ppm													
	Atlas H10 (L-band) ¹	0.04 m	0.08 m													
	SBAS (WAAS) ¹	0.3 m	0.6 m													
Autonomous, no SA ¹	1.2 m	2.5 m														
Heading accuracy ^{1,5}	< 0.17° RMS @ 0.5 m antenna separation < 0.09° RMS @ 1.0 m antenna separation < 0.04° RMS @ 2.0 m antenna separation < 0.02° RMS @ 5.0 m antenna separation < 0.01° RMS @ 10.0 m antenna separation															
Pitch/roll accuracy	< 1° RMS															

Continued on next page

VS1000 Technical Specifications, Continued

VS1000
Technical
specifications,
 continued

Table A-1: GNSS sensor (continued)

Item	Specification
Heave accuracy	30 cm (DGNSS), 10 cm (RTK) ³
Rate of turn	90°/s maximum
Cold start time	< 40 s typical (no almanac, ephemeris, or position)
Warm start time	< 20 s typical (almanac)
Hot start time	< 5 s (almanac, ephemeris, and position)
Heading fix	< 10 s typical (valid position)
Maximum speed	1,850 kph (999 kts)
Maximum altitude	18,288 m (60,000 ft)

Table A-2: L-band sensor

Item	Specification
Receiver Type	Single Channel
Channels	1525 to 1560 MHz
Sensitivity	-140 dBm
Channel Spacing	5.0 kHz
Satellite Selection	Manual and Automatic
Reacquisition Time	15 seconds (typical)
Processor	DSP for demodulation and protocol decoding module provides processing for differential algorithms

Continued on next page

VS1000 Technical Specifications, Continued

VS1000
Technical
specifications,
 continued

Table A-3: Communication

Item	Specification
Ports	CAN, Ethernet, 12-pin multi-purpose (RS-232, RS-422, CAN, Event Marker, 1PPS), 1PPS
Baud Rates	4800-230400
Radio Interfaces	Bluetooth 2.0 (Class 2), Wi-Fi 2.4 GHz
Data Protocols	NMEA 0183, Hemisphere proprietary binary
Correction Protocols	Atlas, ROX, RTCM v2.3 (DGNSS), RTCM v3.2, CMR, CMR+4

Table A-4: Power

Item	Specification
Power input voltage	8 to 36 VDC
Power consumption	< 6.2 W nominal (GNSS L1/L2 L-band) < 5.3 W nominal (GNSS L1/L2 RTK)
Reverse polarity protection	Yes
Antenna short circuit protection	Yes
Antenna input impedance	50 Ω

Continued on next page

VS1000 Technical Specifications, Continued

VS1000
Technical
specifications,
 continued

Table A-5: Environmental

Item	Specification
Operating temperature	-40°C to +70°C (-40°F to +158°F)
Storage temperature	-40°C to +85°C (-40°F to +185°F)
Humidity	95%, non-condensing
Enclosure rating	IP67
Vibration	IEC 60945:2002 Section 8.7
EMC	EN 301 489-1 V2.1.1 EN 301 489-5 V2.1.1 EN 301 489-19 V2.1.0 EN 303 413 V1.1.1

Table A-6: Mechanical

Item	Specification
Dimensions	23.8 L x 16.5 W x 7.9 H (cm) 9.4 L x 6.5 W x 3.1 H (in)
Weight	1.7 Kg
Status indications (LEDs)	Power, primary antenna, secondary antenna, heading, quality, Atlas, CAN1, CAN2, Ethernet
Power connector	CAN, 12-pin ODU metal circular
Data connectors	(1) 12-pin ODU metal circular (1) 8-pin Ethernet (1) CAN (1) USB (1) 1PPS
Antenna connectors	(3) TNC

¹ Depends on multipath environment, number of satellites in view, satellite geometry, and ionospheric activity

² Depends also on baseline length

³ Based on a 40 second time count

⁴ CMR and CMR+ do not cover proprietary messages outside of the typical standard

⁵ Antenna separation 5m or greater require multi-frequency capability

Continued on next page

VS1000 Technical Specifications, Continued

A45 Antenna specifications

Tables A -7 through A-11 list the technical specifications of the A45 antenna.

Table A-7: GNSS antenna

Specification	Description
GNSS Reception	GPS L1/L2/L5 GLONASS G1/G2 BeiDou B1/B2/B3 GALILEO E1/E5 QZSS L1/L2/L5 SBAS
GNSS frequency	1.165 to 1.278 GHz 1.525 to 1.615 GHz
LNA gain	30dB
LNA noise	2.0dB, typical

Table A-8: L-band sensor

Specification	Description
L-band frequency	1.525 - 1.585 GHz
L-band LNA gain	30dB

Table A-9: Power

Specification	Description
Input voltage	3.3 to 15 VDC
Input current	25 mA, typical

Continued on next page

VS1000 Technical Specifications, Continued

A45 Antenna specifications, continued

Table A-10: Mechanical

Specification	Description
Enclosure	Aluminum base with Lexan™ plastic cap
Dimensions	4.7 H x 15.2 D (cm) 1.8 H x 6.0 D (in)
Weight	0.50 kg (1.1 lbs.)
Mount	5/8" female thread
Connector	TNC

Table A-11: Environmental

Specification	Description
Storage temperature	-40°C to +85°C (-40°F to +185°F)
Operating temperature	-40°C to +70°C (-40°F to +158°F)
Enclosure rating	IP69K
Shock and vibration	EP 455
Phase Center Variation	Less than 2 mm at GPS L1, for elevations above 15°

Appendix B: Menu Maps

Overview

Introduction

Appendix B contains the menu maps you need to navigate the WebUI.

Contents

Topic	See Page
VS1000 Menu Map	100

VS1000 Menu Map

Vector Menu

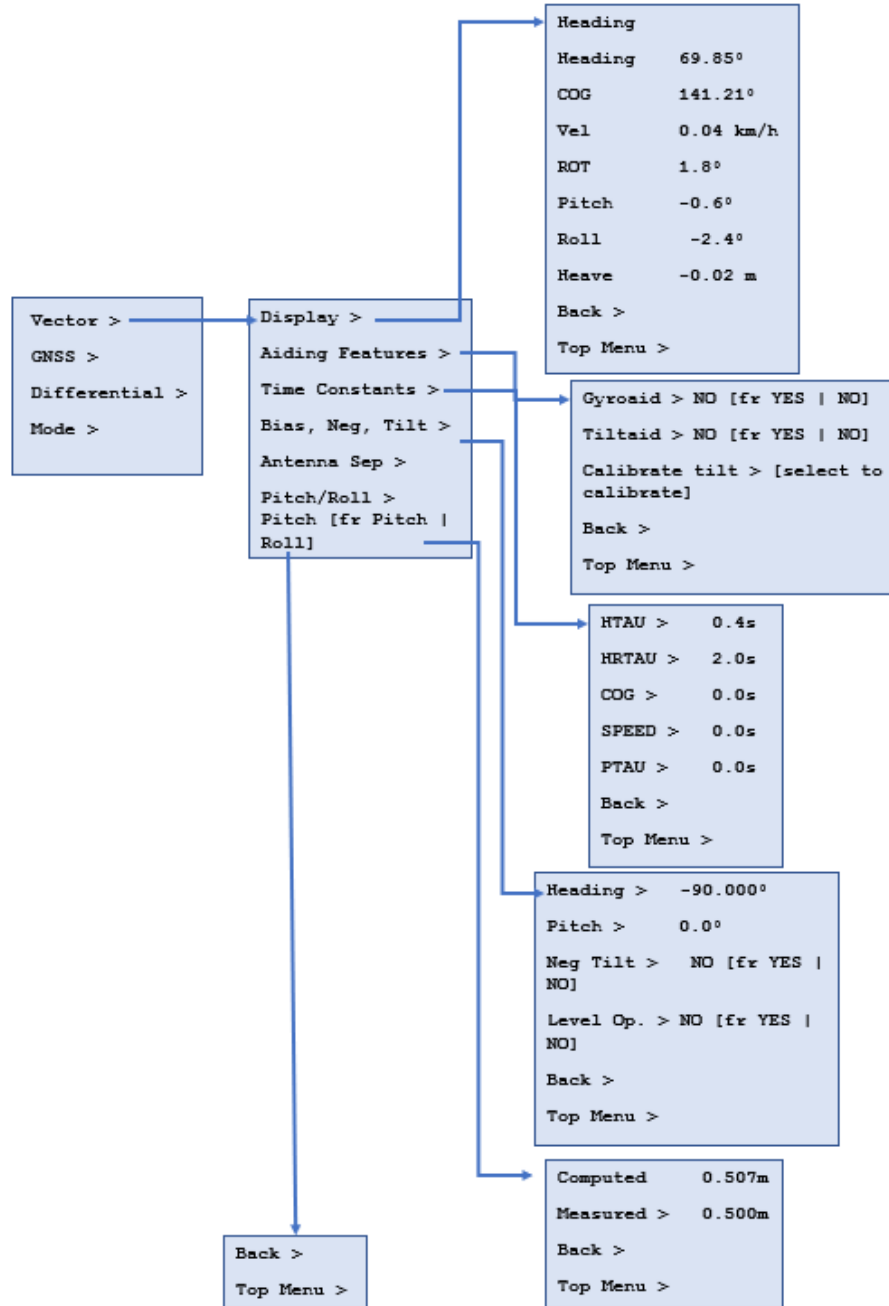

VS1000 Menu Map, Continued

GNSS Menu

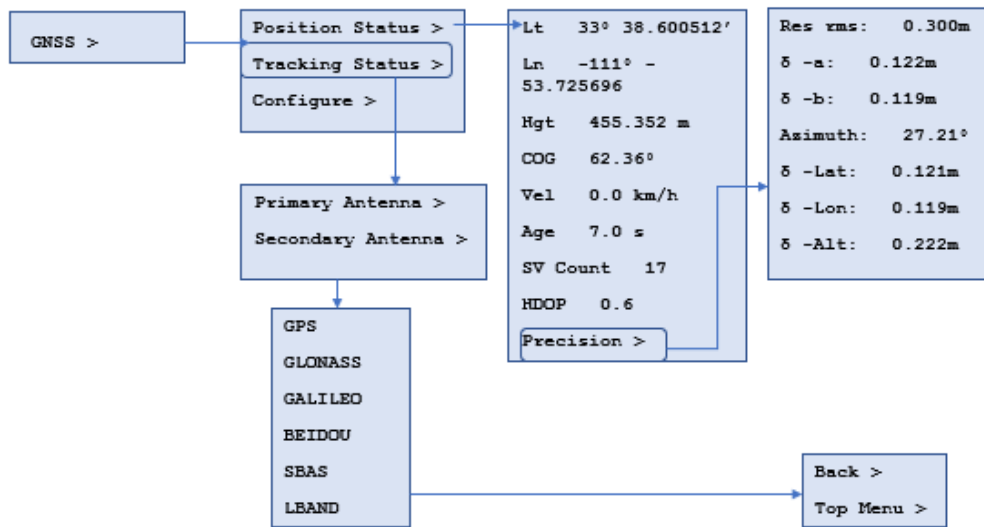

Continued on next page

VS1000 Menu Map, Continued

GNSS Menu, continued

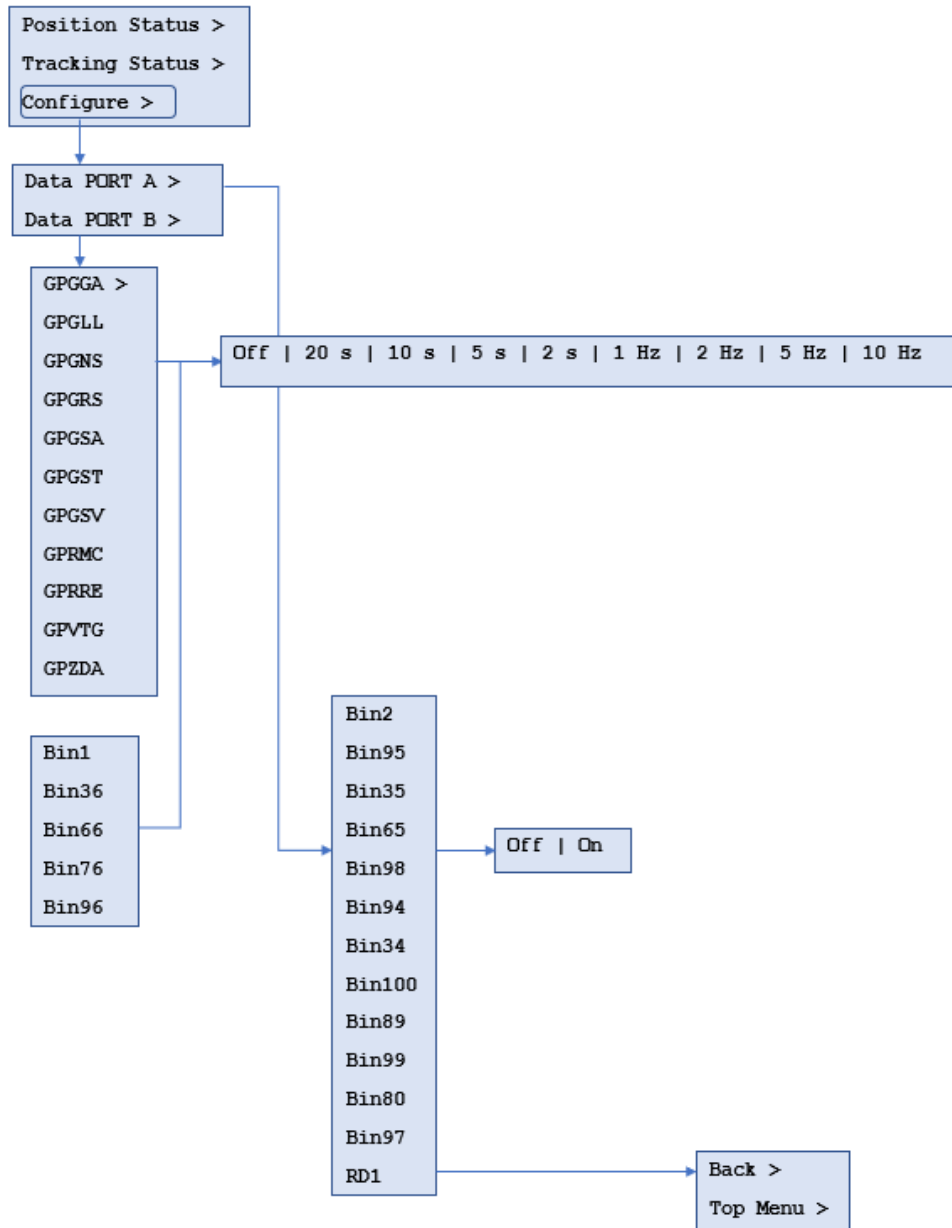

Continued on next page

VS1000 Menu Map, Continued

System Setup

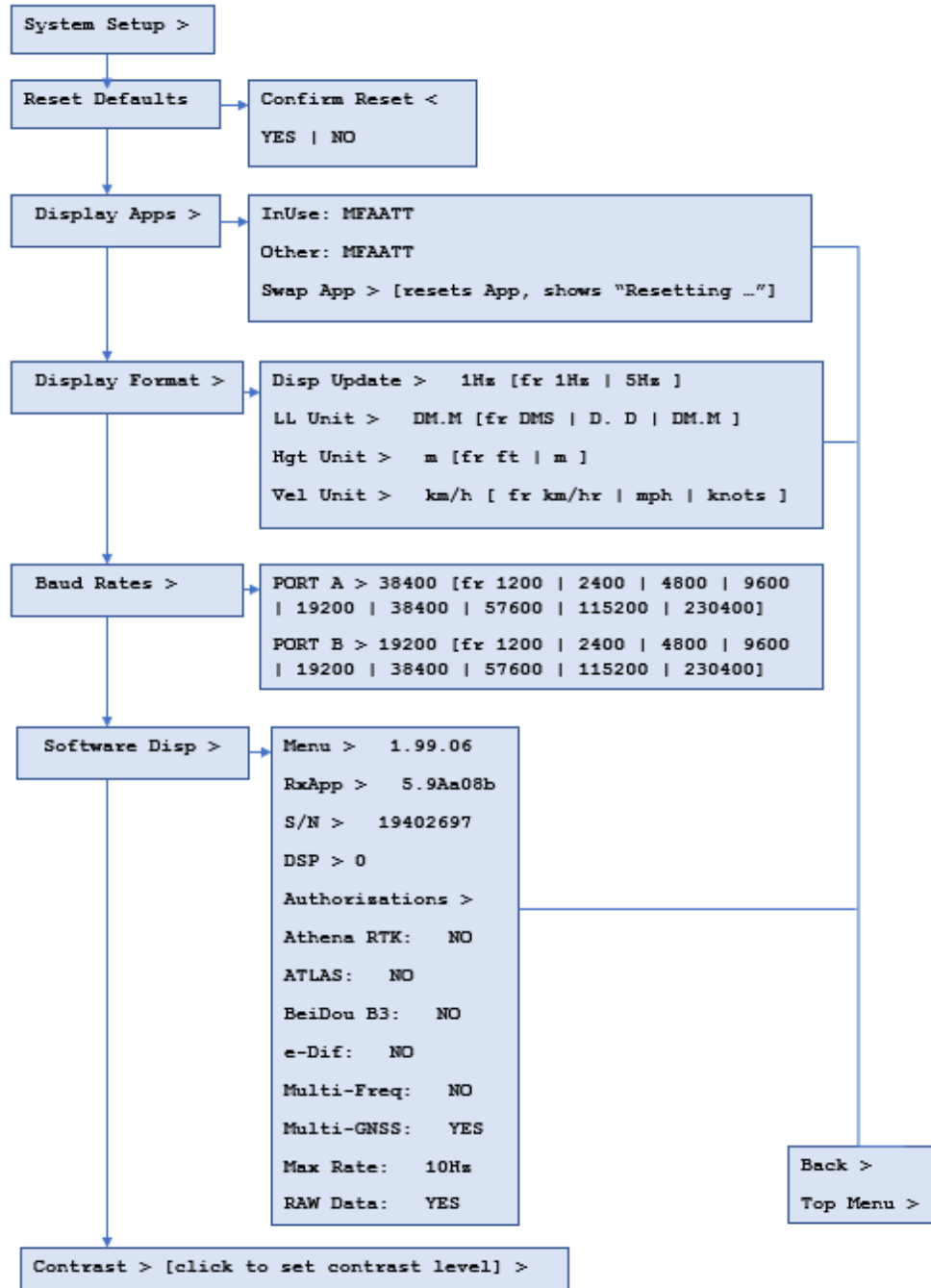

Continued on next page

VS1000 Menu Map, Continued

System Setup, continued

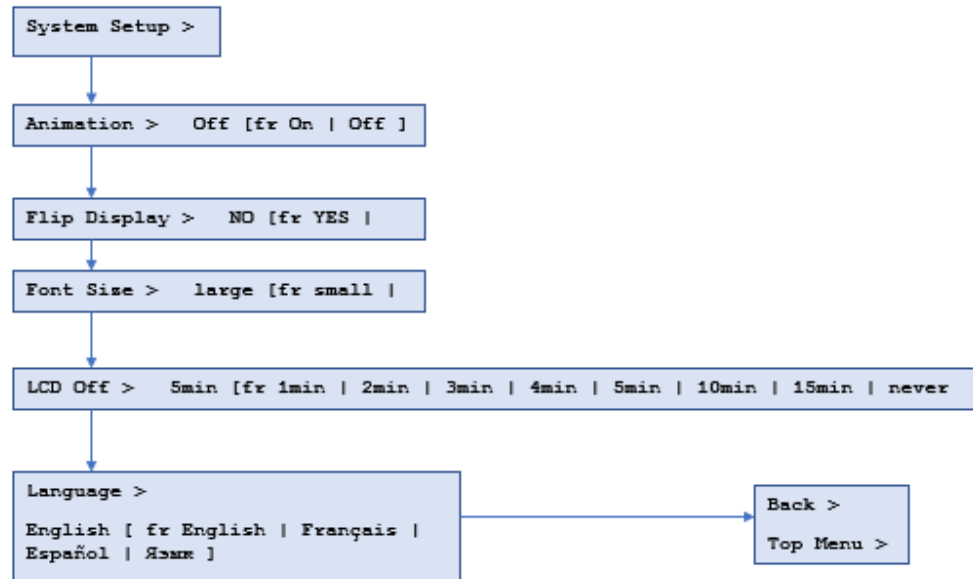

Index

1PPS	6
Activate Loader	16
Activation.....	6
ANT-S10	22, 23, 24, 25, 98
Athena RTK	10, 11, 12
Atlas	6, 62
Atlas Datum	62
Atlas L-band	10, 11, 12, 18
Base Station	6
Baud Rates	38
BeiDou	6
Bluetooth.....	42, 49
CAN	6, 18, 34, 35, 36, 97
course-over-ground.....	55, 78
environmental	27
Ethernet.....	72
firmware	14, 15, 16, 17
Firmware.....	7, 14, 45
GALILEO	7
GGA.....	59, 60
GLONASS.....	7
GPS.....	7, 8
Gyro aiding	52, 75
Heading.....	42, 43, 51, 52, 59, 65, 66, 74, 75
HTAU.....	53, 76
kit	13
LED Indicators	41
Logging.....	58, 59, 60
Message Types	38
Multipath.....	7
NMEA.....	7, 56, 67, 79
NMEA commands	83
NTRIP	7, 11
PEAK.....	18
phase center	11, 22
PocketMax4.....	18
Position.....	43, 66
Power/Data cable.....	28
Program Type	15
Radio.....	8
RightArm.....	14

ROX	8
RTCM	8
RTK.....	6, 8, 52, 62, 75
SBAS.....	8, 42, 43, 65, 66, 81
Serial Output.....	56, 67, 79
Speed	54, 60, 77
Status.....	42, 43, 65, 66
Subscription.....	6, 49
UHF	6
WAAS.....	8
WebUI.....	14, 42, 64

End User License Agreement

End User license agreement

IMPORTANT - This is an agreement (the "**Agreement**") between you, the end purchaser ("**Licensee**") and Hemisphere GNSS Inc. ("**Hemisphere**") which permits Licensee to use the Hemisphere software (the "**Software**") that accompanies this Agreement. This Software may be licensed on a standalone basis or may be embedded in a Product. Please read and ensure that you understand this Agreement before installing or using the Software Update or using a Product.

In this agreement any product that has Software embedded in it at the time of sale to the Licensee shall be referred to as a "**Product**". As well, in this Agreement, the use of a Product shall be deemed to be use of the Software which is embedded in the Product.

BY INSTALLING OR USING THE SOFTWARE UPDATE OR THE PRODUCT, LICENSEE THEREBY AGREES TO BE LEGALLY BOUND BY THE TERMS OF THIS AGREEMENT. IF YOU DO NOT AGREE TO THESE TERMS, (I) DO NOT INSTALL OR USE THE SOFTWARE, AND (II) IF YOU ARE INSTALLING AN UPDATE TO THE SOFTWARE, DO NOT INSTALL THE UPDATE AND PROMPTLY DESTROY IT.

HEMISPHERE PROVIDES LIMITED WARRANTIES IN RELATION TO THE SOFTWARE. AS WELL, THOSE WHO USE THE EMBEDDED SOFTWARE DO SO AT THEIR OWN RISK. YOU SHOULD UNDERSTAND THE IMPORTANCE OF THESE AND OTHER LIMITATIONS SET OUT IN THIS AGREEMENT BEFORE INSTALLING OR USING THE SOFTWARE OR THE PRODUCT.

1. **LICENSE.** Hemisphere hereby grants to Licensee a non-transferable and non-exclusive license to use the Software as embedded in a Product and all Updates (collectively the "**Software**"), solely in binary executable form.
2. **RESTRICTIONS ON USE.** Licensee agrees that Licensee and its employees will not directly or indirectly, in any manner whatsoever:
 - a. install or use more copies of the Software than the number of copies that have been licensed;
 - b. use or install the Software in connection with any product other than the Product the Software was intended to be used or installed on as set out in the documentation that accompanies the Software.
 - c. copy any of the Software or any written materials for any purpose except as part of Licensee's normal backup processes;
 - d. modify or create derivative works based on the Software;
 - e. sub-license, rent, lease, loan or distribute the Software;
 - f. permit any third party to use the Software;
 - g. use or operate Product for the benefit of any third party in any type of service outsourcing, application service, provider service or service bureau capacity;
 - h. reverse engineer, decompile or disassemble the Software or otherwise reduce it to a human perceivable form;
 - i. Assign this Agreement or sell or otherwise transfer the Software to any other party except as part of the sale or transfer of the whole Product.
3. **UPDATES.** At Hemisphere's discretion Hemisphere may make Updates available to Licensee. An update ("**Update**") means any update to the Software that is made available to Licensee including error corrections, enhancements and other modifications. Licensee may access, download and install Updates during the Warranty Period only. All Updates that Licensee downloads, installs or uses shall be deemed to be Software and subject to this Agreement. Hemisphere reserves the right to modify the Product without any obligation to notify, supply or install any improvements or alterations to existing Software.
4. **SUPPORT.** Hemisphere may make available directly or through its authorized dealers telephone and email support for the Software. Contact Hemisphere to find the authorized dealer near you. As well, Hemisphere may make available user and technical documentation regarding the Software. Hemisphere reserves the right to reduce and limit access to such support at any time.

Continued on next page

End User License Agreement, Continued

End User license agreement, continued

5. **BACKUPS AND RECOVERY.** Licensee shall back-up all data used, created or stored by the Software on a regular basis as necessary to enable proper recovery of the data and related systems and processes in the event of a malfunction in the Software or any loss or corruption of data caused by the Software. Licensee shall assume all risks of loss or damage for any failure to comply with the foregoing.
6. **OWNERSHIP.** Hemisphere and its suppliers own all rights, title and interest in and to the Software and related materials, including all intellectual property rights. The Software is licensed to Licensee, not sold.
7. **TRADEMARKS.** "Hemisphere GNSS", "Crescent", "Eclipse" and the associated logos are trademarks of Hemisphere. Other trademarks are the property of their respective owners. Licensee may not use any of these trademarks without the consent of their respective owners.
8. **LIMITED WARRANTY.** Hemisphere warrants solely to the Licensee, subject to the exclusions and procedures set forth herein below, that for a period of one (1) year from the original date of purchase of the Product in which it is embedded (the "Warranty Period"), the Software, under normal use and maintenance, will conform in all material respects to the documentation provided with the Software and any media will be free of defects in materials and workmanship. For any Update, Hemisphere warrants, for 90 days from performance or delivery, or for the balance of the original Warranty Period, whichever is greater, that the Update, under normal use and maintenance, will conform in all material respects to the documentation provided with the Update and any media will be free of defects in materials and workmanship. Notwithstanding the foregoing, Hemisphere does not warrant that the Software will meet Licensee's requirements or that its operation will be error free.
9. **WARRANTY EXCLUSIONS.** The warranty set forth in Section (8) will not apply to any deficiencies caused by (a) the Product not being used as described in the documentation supplied to Licensee, (b) the Software having been altered, modified or converted in any way by anyone other than Hemisphere approved by Hemisphere, (c) any malfunction of Licensee's equipment or other software, or (d) damage occurring in transit or due to any accident, abuse, misuse, improper installation, lightning (or other electrical discharge) or neglect other than that caused by Hemisphere. Hemisphere GNSS does not warrant or guarantee the precision or accuracy of positions obtained when using the Software (whether standalone or embedded in a Product). The Product and the Software is not intended and should not be used as the primary means of navigation or for use in safety of life applications. The potential positioning and navigation accuracy obtainable with the Software as stated in the Product or Software documentation serves to provide only an estimate of achievable accuracy based on specifications provided by the US Department of Defense for GPS positioning and DGPS service provider performance specifications, where applicable.
10. **WARRANTY DISCLAIMER.** EXCEPT AS EXPRESSLY SET OUT IN THIS AGREEMENT, HEMISPHERE MAKES NO REPRESENTATION, WARRANTY OR CONDITION OF ANY KIND TO LICENSEE, WHETHER VERBAL OR WRITTEN AND HEREBY DISCLAIMS ALL REPRESENTATIONS, WARRANTIES AND CONDITIONS OF ANY KIND INCLUDING FITNESS FOR A PARTICULAR PURPOSE, MERCHANTABILITY, ACCURACY, RELIABILITY OR THAT THE USE OF THE SOFTWARE WILL BE UNINTERRUPTED OR ERROR-FREE AND HEREBY DISCLAIMS ALL REPRESENTATIONS, WARRANTIES AND CONDITIONS ARISING AS A RESULT OF CUSTOM, USAGE OR TRADE AND THOSE ARISING UNDER STATUTE.
11. **LIMITS ON WARRANTY DISCLAIMER.** Some jurisdictions do not allow the exclusion of implied warranties or conditions, so some of the above exclusions may not apply to Licensee. In that case, any implied warranties or conditions which would then otherwise arise will be limited in duration to ninety (90) days from the date of the license of the Software or the purchase of the Product. The warranties given herein give Licensee specific legal rights and Licensee may have other rights which may vary from jurisdiction to jurisdiction.
12. **CHANGE TO WARRANTY.** No employee or agent of Hemisphere is authorized to change the warranty provided or the limitation or disclaimer of warranty provisions. All such changes will only be effective if pursuant to a separate agreement signed by senior officers of the respective parties.

Continued on next page

End User License Agreement, Continued

End User license agreement, continued

13. **WARRANTY CLAIM.** In the event Licensee has a warranty claim Licensee must first check for and install all Updates that are made available. The warranty will not otherwise be honored. Proof of purchase may be required. Hemisphere does not honor claims asserted after the end of the Warranty Period.
14. **LICENSEE REMEDIES.** In all cases which involve a failure of the Software to conform in any material respect to the documentation during the Warranty Period or a breach of a warranty, Hemisphere's sole obligation and liability, and Licensee's sole and exclusive remedy, is for Hemisphere, at Hemisphere's option, to (a) repair the Software, (b) replace the Software with software conforming to the documentation, or (c) if Hemisphere is unable, on a reasonable commercial basis, to repair the Software or to replace the Software with conforming software within ninety (90) days, to terminate this Agreement and thereafter Licensee shall cease using the Software. Hemisphere will also issue a refund for the price paid by Licensee less an amount on account of amortization, calculated on a straight-line basis over a deemed useful life of three (3) years.
15. **LIMITATION OF LIABILITY.** IN NO EVENT WILL HEMISPHERE BE LIABLE TO LICENSEE FOR ANY INCIDENTAL, CONSEQUENTIAL, SPECIAL OR INDIRECT DAMAGES INCLUDING ARISING IN RELATION TO ANY LOSS OF DATA, INCOME, REVENUE, GOODWILL OR ANTICIPATED SAVINGS EVEN IF HEMISPHERE HAS BEEN INFORMED OF THE POSSIBILITY OF SUCH LOSS OR DAMAGE. FURTHER, IN NO EVENT WILL HEMISPHERE'S TOTAL CUMULATIVE LIABILITY HEREUNDER, FROM ALL CAUSES OF ACTION OF ANY KIND, EXCEED THE TOTAL AMOUNT PAID BY LICENSEE TO HEMISPHERE TO PURCHASE THE PRODUCT. THIS LIMITATION AND EXCLUSION APPLIES IRRESPECTIVE OF THE CAUSE OF ACTION, INCLUDING BUT NOT LIMITED TO BREACH OF CONTRACT, NEGLIGENCE, STRICT LIABILITY, TORT, BREACH OF WARRANTY, MISREPRESENTATION OR ANY OTHER LEGAL THEORY AND WILL SURVIVE A FUNDAMENTAL BREACH.
16. **LIMITS ON LIMITATION OF LIABILITY.** Some jurisdictions do not allow for the limitation or exclusion of liability for incidental or consequential damages, so the above limitation or exclusion may not apply to Licensee and Licensee may also have other legal rights which may vary from jurisdiction to jurisdiction.
17. **BASIS OF BARGAIN.** Licensee agrees and acknowledges that Hemisphere has set its prices and the parties have entered into this Agreement in reliance on the limited warranties, warranty disclaimers and limitations of liability set forth herein, that the same reflect an agreed-to allocation of risk between the parties (including the risk that a remedy may fail of its essential purpose and cause consequential loss), and that the same forms an essential basis of the bargain between the parties. Licensee agrees and acknowledges that Hemisphere would not have been able to sell the Product at the amount charged on an economic basis without such limitations.
18. **PROPRIETARY RIGHTS INDEMNITY.** Hemisphere shall indemnify, defend and hold harmless Licensee from and against any and all actions, claims, demands, proceedings, liabilities, direct damages, judgments, settlements, fines, penalties, costs and expenses, including royalties and attorneys' fees and related costs, in connection with or arising out of any actual infringement of any third party patent, copyright or other intellectual property right by the Software or by its use, in accordance with this Agreement and documentation, PROVIDED THAT: (a) Hemisphere has the right to assume full control over any action, claim, demand or proceeding, (b) Licensee shall promptly notify Hemisphere of any such action, claim, demand, or proceeding, and (c) Licensee shall give Hemisphere such reasonable assistance and tangible material as is reasonably available to Licensee for the defense of the action, claim, demand or proceeding. Licensee shall not settle or compromise any of same for which Hemisphere has agreed to assume responsibility without Hemisphere's prior written consent. Licensee may, at its sole cost and expense, retain separate counsel from the counsel utilized or retained by Hemisphere. 19. **INFRINGEMENT.** If use of the Software may be enjoined due to a claim of infringement by a third party then, at its sole discretion and expense, Hemisphere may do one of the following: (a) negotiate a license or other agreement so that the Product is no longer subject to such a potential claim, (b) modify the Product so that it becomes non-infringing, provided such modification can be accomplished without materially affecting the performance and functionality of the Product,

Continued on next page

End User License Agreement, Continued

End User license agreement, continued

- (c) replace the Software, or the Product, with non-infringing software, or product, of equal or better performance and quality, or (d) if none of the foregoing can be done on a commercially reasonable basis, terminate this license and Licensee shall stop using the Product and Hemisphere shall refund the price paid by Licensee less an amount on account of amortization, calculated on a straight-line basis over a deemed useful life of three (3) years.
19. The foregoing sets out the entire liability of Hemisphere and the sole obligations of Hemisphere to Licensee in respect of any claim that the Software or its use infringes any third party rights.
20. **INDEMNIFICATION.** Except in relation to an infringement action, Licensee shall indemnify and hold Hemisphere harmless from any and all claims, damages, losses, liabilities, costs and expenses (including reasonable fees of lawyers and other professionals) arising out of or in connection with Licensee's use of the Product, whether direct or indirect, including without limiting the foregoing, loss of data, loss of profit or business interruption. **TERMINATION.** Licensee may terminate this Agreement at any time without cause. Hemisphere may terminate this Agreement on 30 days notice to Licensee if Licensee fails to materially comply with each provision of this Agreement unless such default is cured within the 30 days. Any such termination by a party shall be in addition to and without prejudice to such rights and remedies as may be available, including injunction and other equitable remedies. Upon receipt by Licensee of written notice of termination from Hemisphere or termination by Licensee, Licensee shall at the end of any notice period (a) cease using the Software; and (b) return to Hemisphere (or destroy and provide a certificate of a Senior Officer attesting to such destruction) the Software and all related material and any magnetic or optical media provided to Licensee. The provisions of Sections 6), 7), 8), 9), 10), 15), 21), 26) and 27) herein shall survive the expiration or termination of this Agreement for any reason.
21. **EXPORT RESTRICTIONS.** Licensee agrees that Licensee will comply with all export control legislation of Canada, the United States, Australia and any other applicable country's laws and regulations, whether under the Arms Export Control Act, the International Traffic in Arms Regulations, the Export Administration Regulations, the regulations of the United States Departments of Commerce, State, and Treasury, or otherwise as well as the export control legislation of all other countries.
22. **PRODUCT COMPONENTS.** The Product may contain third party components. Those third party components may be subject to additional terms and conditions. Licensee is required to agree to those terms and conditions in order to use the Product.
23. **FORCE MAJEURE EVENT.** Neither party will have the right to claim damages as a result of the other's inability to perform or any delay in performance due to unforeseeable circumstances beyond its reasonable control, such as labor disputes, strikes, lockouts, war, riot, insurrection, epidemic, Internet virus attack, Internet failure, supplier failure, act of God, or governmental action not the fault of the non-performing party.
24. **FORUM FOR DISPUTES.** The parties agree that the courts located in Calgary, Alberta, Canada and the courts of appeal there from will have exclusive jurisdiction to resolve any disputes between Licensee and Hemisphere concerning this Agreement or Licensee's use or inability to use the Software and the parties hereby irrevocably agree to attorn to the jurisdiction of those courts. Notwithstanding the foregoing, either party may apply to any court of competent jurisdiction for injunctive relief.
25. **APPLICABLE LAW.** This Agreement shall be governed by the laws of the Province of Alberta, Canada, exclusive of any of its choice of law and conflicts of law jurisprudence.
26. **CISG.** The United Nations Convention on Contracts for the International Sale of Goods will not apply to this Agreement or any transaction hereunder.

GENERAL. This is the entire agreement between Licensee and Hemisphere relating to the Product and Licensee's use of the same, and supersedes all prior, collateral or contemporaneous oral or written representations, warranties or agreements regarding the same. No amendment to or modification of this Agreement will be binding unless in writing and signed by duly authorized representatives of the parties. Any and all terms and conditions set out in any correspondence between the parties or set out in a purchase order which are different from or in addition to the terms and conditions set forth herein, shall have no application and no written notice of same shall be required. In the event that one or more of the provisions of this Agreement is found to be illegal or unenforceable, this Agreement shall not be rendered inoperative but the remaining provisions shall continue in full force and effect.

Warranty Notice

Warranty notice

COVERED PRODUCTS: This warranty covers all products manufactured by Hemisphere GNSS and purchased by the end purchaser (the "Products"), unless otherwise specifically and expressly agreed in writing by Hemisphere GNSS.

LIMITED WARRANTY: Hemisphere GNSS warrants solely to the end purchaser of the Products, subject to the exclusions and procedures set forth below, that the Products sold to such end purchaser and its internal components shall be free, under normal use and maintenance, from defects in materials, and workmanship and will substantially conform to Hemisphere GNSS's applicable specifications for the Product, for a period of 12 months from delivery of such Product to such end purchaser (the "Warranty Period"). Repairs and replacement components for the Products are warranted, subject to the exclusions and procedures set forth below, to be free, under normal use and maintenance, from defects in material and workmanship, and will substantially conform to Hemisphere GNSS's applicable specifications for the Product, for 90 days from performance or delivery, or for the balance of the original Warranty Period, whichever is greater.

EXCLUSION OF ALL OTHER WARRANTIES. The LIMITED WARRANTY shall apply only if the Product is properly and correctly installed, configured, interfaced, maintained, stored, and operated in accordance with Hemisphere GNSS relevant User's Manual and Specifications, AND the Product is not modified or misused. The Product is provided "AS IS" and the implied warranties of MERCHANTABILITY and FITNESS FOR A PARTICULAR PURPOSE and ALL OTHER WARRANTIES,

express, implied or arising by statute, by course of dealing or by trade usage, in connection with the design, sale, installation, service or use of any products or any component thereof, are EXCLUDED from this transaction and shall not apply to the Product. The LIMITED WARRANTY is IN LIEU OF any other warranty, express or implied, including but not limited to, any warranty of MERCHANTABILITY or FITNESS FOR A PARTICULAR PURPOSE, title, and non-infringement.

LIMITATION OF REMEDIES. The purchaser's EXCLUSIVE REMEDY against Hemisphere GNSS shall be, at Hemisphere GNSS's option, the repair or replacement of any defective Product or components thereof. The purchaser shall notify Hemisphere GNSS or a Hemisphere GNSS's approved service center immediately of any defect. Repairs shall be made through a Hemisphere GNSS approved service center only. Repair, modification or service of Hemisphere GNSS products by any party other than a Hemisphere GNSS approved service center shall render this warranty null and void. The remedy in this paragraph shall only be applied in the event that the Product is properly and correctly installed, configured, interfaced, maintained, stored, and operated in accordance with Hemisphere GNSS's relevant User's Manual and Specifications, AND the Product is not modified or misused. NO OTHER REMEDY (INCLUDING, BUT NOT LIMITED TO, SPECIAL, INDIRECT, INCIDENTAL, CONSEQUENTIAL OR CONTINGENT DAMAGES FOR LOST PROFITS, LOST SALES, INJURY TO PERSON OR PROPERTY, OR ANY OTHER INCIDENTAL OR CONSEQUENTIAL LOSS) SHALL BE AVAILABLE

TO PURCHASER, even if Hemisphere GNSS has been advised of the possibility of such damages. Without limiting the foregoing, Hemisphere GNSS shall not be liable for any damages of any kind resulting from installation, use, quality, performance or accuracy of any Product.

HEMISPHERE IS NOT RESPONSIBLE FOR PURCHASER'S NEGLIGENCE OR UNAUTHORIZED USES OF THE PRODUCT.

IN NO EVENT SHALL Hemisphere GNSS BE IN ANY WAY RESPONSIBLE FOR ANY DAMAGES RESULTING FROM PURCHASER'S OWN NEGLIGENCE, OR FROM OPERATION OF THE PRODUCT IN ANY WAY OTHER THAN AS SPECIFIED IN Hemisphere GNSS's RELEVANT USER'S MANUAL AND SPECIFICATIONS. Hemisphere GNSS is NOT RESPONSIBLE for defects or performance problems resulting from (1) misuse, abuse, improper installation, neglect of Product; (2) the utilization of the Product with hardware or software products, information, data, systems, interfaces or devices not made, supplied or specified by Hemisphere GNSS; (3) the operation of the Product under any specification other than, or in addition to, the specifications set forth in Hemisphere GNSS's relevant User's Manual and Specifications; (4) damage caused by accident or natural events, such as lightning (or other electrical discharge) or fresh/ salt water immersion of Product; (5) damage occurring in transit; (6) normal wear and tear; or (7) the operation or failure of operation of any satellite-based positioning system or differential correction service; or the availability or performance of any satellite-based positioning signal or differential correction signal.

THE PURCHASER IS RESPONSIBLE FOR OPERATING THE VEHICLE SAFELY. The purchaser is solely responsible for the safe operation of the vehicle used in connection with the Product, and for maintaining proper system control settings. UNSAFE DRIVING OR SYSTEM CONTROL SETTINGS CAN RESULT IN PROPERTY DAMAGE, INJURY, OR DEATH.

Continued on next page

Warranty Notice, Continued

Warranty notice, continued

The purchaser is solely responsible for his/her safety and for the safety of others. The purchaser is solely responsible for maintaining control of the automated steering system at all times. THE PURCHASER IS SOLELY RESPONSIBLE FOR ENSURING THE PRODUCT IS PROPERLY AND CORRECTLY INSTALLED, CONFIGURED, INTERFACED, MAINTAINED, STORED, AND OPERATED IN ACCORDANCE WITH Hemisphere GNSS's RELEVANT USER'S MANUAL AND SPECIFICATIONS. Hemisphere GNSS does not warrant or guarantee the positioning and navigation precision or accuracy obtained when using Products. Products are not intended for primary navigation or for use in safety of life applications. The potential accuracy of Products as stated in Hemisphere GNSS literature and/or Product specifications serves to provide only an estimate of achievable accuracy based on performance specifications provided by the satellite service operator (i.e. US Department of Defense in the case of GPS and differential correction service provider. Hemisphere GNSS reserves the right to modify Products without any obligation to notify, supply or install any improvements or alterations to existing Products.

GOVERNING LAW. This agreement and any disputes relating to, concerning or based upon the Product shall be governed by and interpreted in accordance with the laws of the State of Arizona.

OBTAINING WARRANTY SERVICE. In order to obtain warranty service, the end purchaser must bring the Product to a Hemisphere GNSS approved service center along with the end purchaser's proof of purchase. Hemisphere GNSS does not warrant claims asserted after the end of the warranty period. For any questions regarding warranty service or to obtain information regarding the location of any of Hemisphere GNSS approved service center, contact Hemisphere GNSS at the following address:

Hemisphere GNSS

8515 E. Anderson Drive Scottsdale, AZ 85255, USA

Phone: +1-480-348-6380

Fax: +1-480-270-5070

TECHSUPPORT@HREGNSS.COM WWW.HGNSS.COM



Hemisphere GNSS Inc.
8515 East Anderson Drive
Scottsdale, Arizona, US 85255
Phone: 480-348-6380
Fax: 480-270-5070
PRECISION@HGNS.COM
WWW.HGNS.COM